



User Guide



HP LaserJet Pro MFP 3101-3108 series

HP company notices

Copyright and License

THE INFORMATION CONTAINED HEREIN IS SUBJECT TO CHANGE WITHOUT NOTICE.

ALL RIGHTS RESERVED. REPRODUCTION, ADAPTATION, OR TRANSLATION OF THIS MATERIAL IS PROHIBITED WITHOUT PRIOR WRITTEN PERMISSION OF HP, EXCEPT AS ALLOWED UNDER THE COPYRIGHT LAWS. THE ONLY WARRANTIES FOR HP PRODUCTS AND SERVICES ARE SET FORTH IN THE EXPRESS WARRANTY STATEMENTS ACCOMPANYING SUCH PRODUCTS AND SERVICES. NOTHING HEREIN SHOULD BE CONSTRUED AS CONSTITUTING AN ADDITIONAL WARRANTY. HP SHALL NOT BE LIABLE FOR TECHNICAL OR EDITORIAL ERRORS OR OMISSIONS CONTAINED HEREIN.

© Copyright 2021 HP Development Company, L.P.

Trademark Credits

Microsoft® and Windows® are either registered trademarks or trademarks of Microsoft Corporation in the United States and/or other countries.

Mac, macOS, iPadOS, and AirPrint are trademarks of Apple Inc., registered in the U.S. and other countries.

Google Play is a trademark of Google LLC.

ENERGY STAR® and the ENERGY STAR® mark are registered trademarks owned by the U.S. Environmental Protection Agency.

Safety information

Always follow basic safety precautions when using this product to reduce risk of injury from fire or electric shock.

Read and understand all instructions in the documentation that comes with the printer.

Observe all warnings and instructions marked on the product.

Unplug this product from wall outlets before cleaning.

Do not install or use this product near water, or when you are wet.

Install the product securely on a stable surface.

Install the product in a protected location where no one can step on or trip over the line cord, and the line cord cannot be damaged.

If the product does not operate normally, see [Solve problems](#) in this guide.

There are no user-serviceable parts inside. Refer servicing to qualified service personnel.

Table of contents

1 Get started	1
Printer views	1
Printer front view	1
Printer back view	2
Control panel features	2
Lift the control panel	2
Control panel	3
Function buttons	4
Dashboard icons	4
Change printer settings	5
To change settings for a function	5
To change the printer settings	5
Use the HP Smart app to print, scan, and manage	5
To install HP Smart and open the app	6
Get more information about HP Smart	6
Set up Scan to Email	6
Step 1: Set up the outgoing email profiles	7
From embedded web server (EWS) through the HP Printer software	7
From embedded web server (EWS) through web browser	7
Step 2: Add email addresses to the Address Book	7
Step 3: Configure other email options	8
2 Connect your printer	9
Connect your printer to a Wi-Fi network using Control Panel	9
Connect your printer to a Wi-Fi network using HP software	9
Connect your printer to a Wi-Fi network using Wi-Fi Protected Setup (WPS)	10
Connect your printer to an Ethernet network	10
Connect your printer using a USB cable	10
Change wireless settings	11
Turn on or off the wireless capabilities of the printer	11
Change the connection type	11
Change USB to a wireless connection (Windows 7/Windows 10 and above/macOS)	11
Change wireless to a USB connection (Windows/macOS)	11
3 Load media	13
Before you begin	13
Load paper	13
Load envelopes	16
Load labels	17

Load an original on the scanner glass	18
Load an original in the document feeder	20
Change the paper settings	21
To change the paper settings (Windows)	21
To change the paper settings (OS X)	22
To change the default paper settings from the embedded web server	22
4 Print.....	23
Print with mobile devices.....	23
Print while connected to same Wi-Fi network.....	23
Print without connecting to same Wi-Fi network (Wi-Fi Direct)	23
To turn Wi-Fi Direct on or off from the printer control panel	24
To find the Wi-Fi Direct name or password	24
Print using a Windows computer.....	24
Print from a Mac computer	24
5 Copy, Scan, and Mobile Fax	25
Copy.....	25
To copy document or ID card.....	25
Scan.....	25
Scan to a computer	25
To scan an original to a computer from the printer control panel	25
To enable the scan to a computer feature (Windows)	26
Scan to a memory device.....	26
To scan an original to a memory device from the printer control panel.....	26
Set up HP Digital Solutions.....	26
Set up HP Digital Filing	27
Scan to email	28
Scan to email through Scan function.....	28
Email the scanned document or photo	28
Scan using HP Smart (iOS/Android, Windows 10 and above, and macOS)	29
Scan using the HP Scan software (Windows 7).....	29
Scan using Webscan	29
To enable Webscan	30
To scan using Webscan	30
Tips for copy and scan success	30
Mobile Fax.....	30
Use Mobile Fax in the HP Smart app	30
6 Fax.....	32
Send a fax.....	32
Send a standard fax.....	32
To send a standard fax from the printer control panel.....	32
Send a standard fax from the computer	33
To send a standard fax from the computer (Windows)	33
Send a fax from a phone.....	33
To send a fax from an extension phone	33

Send a fax using monitor dialing	34
To send a fax using monitor dialing from the printer control panel	34
Send a fax using printer memory	34
To send a fax using printer memory	34
Send a fax to multiple recipients	35
To send a fax to multiple recipients using group phone book	35
Send a fax in Error Correction Mode.....	35
To change the ECM setting from the control panel	35
Receive a fax	36
Receive a fax manually.....	36
To receive a fax manually	36
Set up backup fax.....	36
To set backup fax from the printer control panel	36
Reprint received faxes from memory	37
To reprint faxes in memory from the printer control panel	37
Forward faxes to another number	37
To forward faxes from the printer control panel.....	38
Set automatic reduction for incoming faxes.....	38
To set automatic reduction from the printer control panel.....	38
Block unwanted fax numbers	38
To add a number to the junk fax list	39
To remove numbers from the junk fax list.....	39
To print a junk fax list	39
Receive faxes using HP Digital Fax.....	40
HP Digital Fax requirements.....	40
To set up or modify HP Digital Fax (Windows)	40
To turn off HP Digital Fax	40
Set up phone book contacts	40
Create and edit a phone book contact.....	40
To set up phone book contacts.....	40
To change phone book contacts.....	41
Create and edit a group phone book contact	41
To set up group phone book contacts	41
To change group phone book contacts	42
Delete phone book contacts	42
To delete phone book contacts.....	42
To delete group phone book contacts	42
Change fax settings	42
Configure the fax header	43
To set or change the fax header	43
Set the answer mode (Auto answer)	43
To set the answer mode	43
Set the number of rings before answering.....	43
To set the number of rings before answering	43
Change the answer ring pattern for distinctive ring.....	44
To change the answer ring pattern for distinctive ring	44
Set the dial type	44
To set the dial type	44

Set the redial options	45
To set the redial options	45
Set the fax speed	45
To set the fax speed	45
Set the fax sound volume.....	46
To set the fax sound volume.....	46
Fax and digital phone services.....	46
Fax on Voice over Internet Protocol	46
Use reports.....	47
Print fax confirmation reports.....	47
To enable fax confirmation.....	47
To include an image of the fax on the report	48
Print fax error reports	48
To set the printer to print fax error reports automatically	48
Print and view the fax log	48
To print the fax log from the printer control panel.....	48
Clear the fax log.....	48
To clear the fax log.....	48
Print the details of the last fax transaction	49
To print the Last Fax Transaction report	49
Print a Caller ID Report	49
To print a Caller ID History Report	49
View the Call History	49
To view the call history.....	49
Additional fax setup.....	49
Set up faxing (parallel phone systems)	50
Select the correct fax setup for your home or office.....	50
Case A: Separate fax line (no voice calls received)	52
Case B: Set up the printer with DSL.....	53
Case C: Set up the printer with a PBX phone system or an ISDN line	54
Case D: Fax with a distinctive ring service on the same line	55
Case E: Shared voice/fax line	56
Case F: Shared voice/fax line with voice mail	57
Case G: Fax line shared with computer modem (no voice calls received).....	59
Case H: Shared voice/fax line with computer modem	61
Case I: Shared voice/fax line with answering machine	65
Case J: Shared voice/fax line with computer modem and answering machine.....	67
Case K: Shared voice/fax line with computer dial-up modem and voice mail	71
Test fax setup	73
7 Configure your printer	75
Use Web Services	75
Set up Web Services	75
Update the printer.....	75
Dynamic Security Enabled Printers	76
Open the HP printer software (Windows)	76

Configure the printer using the Embedded Web Server (EWS).....	76
To access and use the Embedded Web Server (EWS)	76
Things to note when accessing EWS.....	77
To open EWS using HP Smart (iOS, Android, and Windows 10 and above)	77
To open EWS using an IP address (Wi-Fi or Ethernet connection)	77
To open EWS using an IP address (Wi-Fi Direct connection)	78
To open EWS using HP Printer software (Windows 7)	78
Configure IP network settings.....	78
View or change network settings.....	78
Rename the printer on a network	78
Manually configure IPv4 TCP/IP parameters.....	78
Assign or change the system password using the Embedded Web Server	79
Change energy-conservation settings	79
Set the Sleep Mode time.....	79
Change the printer shutdown time and settings	79
8 Supplies, accessories, and parts.....	81
Dynamic Security Enabled Printers	81
Order supplies, accessories, and parts	82
Order	82
Supplies and accessories.....	82
Configure the HP toner-cartridge-protection supply settings.....	83
Enable or disable the Cartridge Policy feature	83
Replace the toner cartridge.....	83
Cartridge information	83
Remove and replace the toner cartridge.....	83
9 Solve problems.....	86
HP support	86
Contact HP.....	86
Register printer.....	86
Additional warranty options.....	86
Additional information	86
Print printer reports.....	87
To print a report from the printer control panel.....	87
To print a report from the EWS	87
Printer reports	87
Restore original factory defaults and settings.....	88
To restore printer default settings using EWS.....	88
To restore network default settings using EWS.....	89
To restore the printer default settings from the printer control panel.....	89
To restore the printer network settings from the printer control panel	89
Cartridge low.....	89
Cartridge is low	90
Cartridge is very low	90
Change the “Very Low” settings	90
Order supplies.....	90

Paper misfeeds and pickup error.....	90
The printer does not pick up paper	90
The printer picks up multiple sheets of paper.....	91
The printer picks up paper in a crossed manner.....	91
Clear paper jams.....	91
Introduction.....	91
Before you begin	91
Jam locations.....	92
Frequent or recurring paper jams?.....	92
Clear jams from the input tray	93
Clear jams from the cartridge access area.....	94
Clear jams in the document feeder	97
Clear jams from the rear of the printer.....	98
Improve print quality	99
Introduction.....	99
Print from a different software program.....	100
Check the paper-type setting for the print job.....	100
Check the paper type setting on the printer.....	100
Check the paper type setting (Windows)	100
Check the paper type setting (OS X)	100
Check toner-cartridge status	100
Print a cleaning page	101
Visually inspect the toner cartridge	101
Check paper and the printing environment	101
Step one: Use paper that meets HP specifications.....	101
Step two: Check the environment	102
Adjust Print Density	102
Resolving print quality problems.....	102
Introduction.....	102
Troubleshoot print quality problems	103
Fax issues	109
Run the fax test.....	109
To test fax setup via the printer control panel	109
What to do if the fax test failed.....	109
The "Fax Hardware Test" failed	109
The "Fax Connected to Active Telephone Wall Jack" test failed	110
The "Phone Cord Connected to Correct Port on Fax" test failed.....	110
The "Using Correct Type of Phone Cord with Fax" test failed.....	111
The "Dial Tone Detection" test failed.....	112
The "Fax Line Condition" test failed.....	113
Troubleshoot fax problems	113
The display always shows Phone Off Hook.....	113
The printer is having problems sending and receiving faxes.....	114
The printer cannot receive faxes, but can send faxes.....	115
The printer cannot send faxes, but can receive faxes.....	116
Fax tones are recorded on my answering machine.....	117
The computer cannot receive faxes (HP Digital Fax).....	117

Solve wireless network problems	117
Introduction.....	117
Wireless connectivity checklist.....	117
The printer does not print after the wireless configuration completes.....	118
The printer does not print, and the computer has a third-party firewall installed.....	118
The wireless connection does not work after moving the wireless router or printer	118
Cannot connect more devices to the wireless printer (Wi-Fi Direct)	119
The printer cannot print when your computer is on a VPN	119
The network does not appear in the wireless networks list	119
The wireless network is not functioning	119
Perform a wireless network diagnostic test.....	120
Method one: Perform a wireless network diagnostic test using the printer control panel.....	120
Method two: Perform wireless network diagnostic test using the EWS	120
Reduce interference on a wireless network.....	120
Solve Ethernet connection problems.....	120
Appendix A Printer specifications	121
Technical specifications.....	121
System requirements	121
Wi-Fi band supported.....	121
Printer dimensions.....	121
Power consumption, electrical specifications, and acoustic emissions	122
Operating-environment range.....	122
Warning icons	122
Laser Warning.....	123
Appendix B Service and support.....	124
HP limited warranty statement	124
Country Specific Terms.....	125
Australia	125
New Zealand	126
UK, Ireland, and Malta.....	127
Austria, Belgium, Germany, and Luxemburg	127
Belgium, France, and Luxemburg.....	128
Italy.....	129
Spain.....	129
Denmark.....	130
Norway.....	130
Sweden	130
Portugal.....	131
Greece and Cyprus	131
Hungary	131
Czech Republic.....	132
Slovakia.....	132
Poland.....	132
Bulgaria.....	132
Romania.....	133

Belgium and the Netherlands	133
Finland	133
Slovenia	134
Croatia	134
Latvia.....	134
Lithuania.....	135
Estonia	135
Russia.....	135
HP's Premium Protection Warranty: LaserJet toner cartridge limited warranty statement.....	135
HP policy on non-Original HP supplies	136
HP anticounterfeit Web site.....	136
Data stored on the toner cartridge.....	136
End User License Agreement	137
Customer self-repair warranty service	141
Customer support.....	142
Appendix C Environmental product stewardship program	143
Protecting the environment	143
Ozone production.....	143
Power consumption.....	143
Toner consumption.....	143
Paper use.....	144
Plastics.....	144
HP LaserJet print supplies	144
Paper	144
Material restrictions	144
Disposal of waste equipment by users (EU and India).....	144
Electronic hardware recycling	145
Hardware recycling information (Brazil).....	145
Chemical substances	145
Product Power Data per European Union Commission Regulation 1275/2008	145
SEPA Ecolabel User Information (China).....	146
The regulation of the implementation on China energy label for printer, and copier	146
Restriction of Hazardous Substances statement (India)	146
WEEE (Turkey).....	146
The Table of Hazardous Substances/Elements and their Content (China)	147
Material Safety Data Sheet (MSDS)	147
EPEAT	147
Declaration of the Presence Condition of the Restricted Substances Marking (Taiwan)	148
For more information	148

Appendix D Regulatory information.....	150
Battery Statements	150
Reese's Law.....	150
UK Battery	150
Regulatory statements	151
European Union and United Kingdom Regulatory Notice.....	151
Regulatory model numbers	151
FCC regulations.....	152
Canada - Industry Canada ICES-003 Compliance Statement	152
Power cord instructions	153
Laser safety	153
Laser statement for Finland.....	153
GS statement (Germany)	154
Nordic Statements (Denmark, Finland, Norway, Sweden).....	154
Taiwan BSMI USB Port (Walk-up) Statement	154
Eurasian Conformity (Armenia, Belarus, Kazakhstan, Kirgizstan, Russia).....	154
Производитель и дата производства	154
Өндіруші және өндіру мерзімі	155
Местные представители	155
Жергілікті өкілдіктері.....	155
Telecom (fax) statements	155
Fax Cord Statement	155
Belarus statement	155
Brazil ANATEL statement	156
Canada	156
Europe Statement for Telecom Operation	157
New Zealand	157
Additional FCC Statement for Telecom Products (US).....	158
Telephone Consumer Protection Act	158
Wireless statements	158
FCC compliance statement—United States.....	159
Australia statement	159
Belarus statement	159
Brazil ANATEL statement	159
Canadian statements	159
China CMIIT Wireless statements.....	160
Korean statement	160
Taiwan statement (Traditional Chinese).....	160
Products with 5 GHz Operation Industry of Canada.....	160
Taiwan NCC Statement:(Only for 5GHz).....	160
Exposure to Radio Frequency Radiation (Canada)	161
European regulatory notice.....	161
Notice for use in Russia.....	161
Mexico statement.....	161
Thailand statement	161
Vietnam Telecom.....	162
Dynamic Security Enabled Printers	162

1 Get started

This section describes the printer parts, control panel features, and other printer functionalities.

Printer views

This topic describes the printer front views, printer back view, control panel features, and HP Smart app.

Printer front view

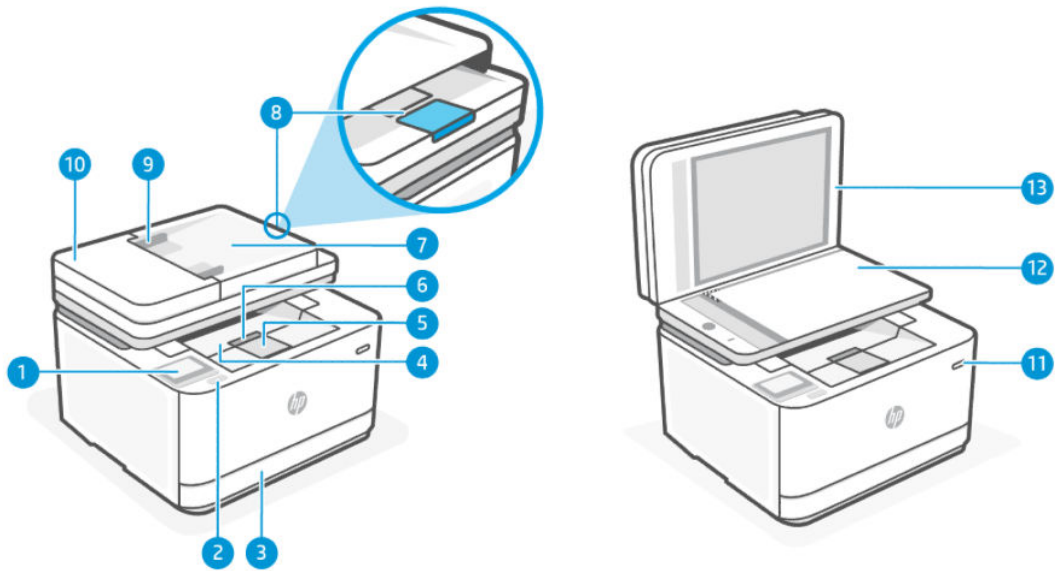

Table 1-1 Printer front view

Feature	Description
1	Control panel display
2	Front USB port
3	Input tray
4	Output tray
5	Output tray extender
6	Cartridge access door
7	Document feeder input tray
8	Document feeder output tray extender
9	Document feeder paper-width guides
10	Document feeder cover
11	Power button

Table 1-1 Printer front view (continued)

Feature	Description
12	Scanner glass
13	Scanner lid

Printer back view

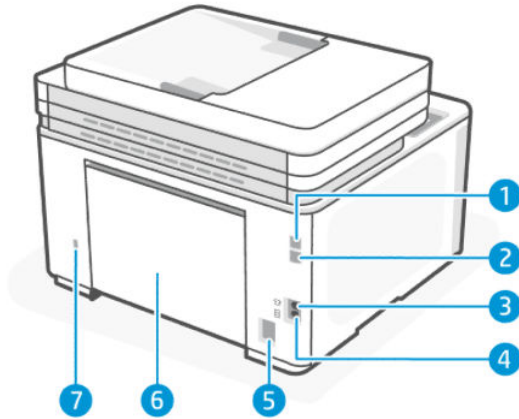



Table 1-2 Printer back view

Feature	Description
1	Rear USB port NOTE: Remove the label covering the USB port if necessary.
2	Ethernet port
3	Fax port  (fax models only)
4	Fax port  (fax models only)
5	Power input
6	Rear access door
7	Security slot

Control panel features

This topic describes the printer control panel features.

Lift the control panel

You can move the control panel for easier use.

- Push the lower part of the control panel to lift it.

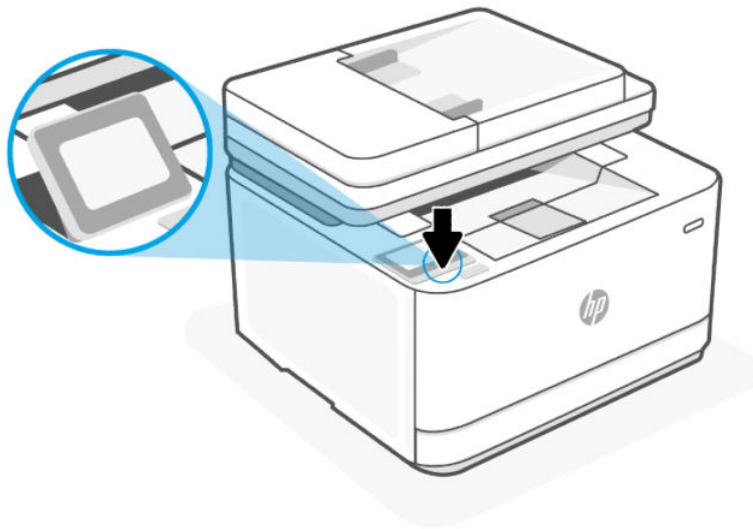

 **NOTE:** Press down the control panel to return it to its original position.

Control panel

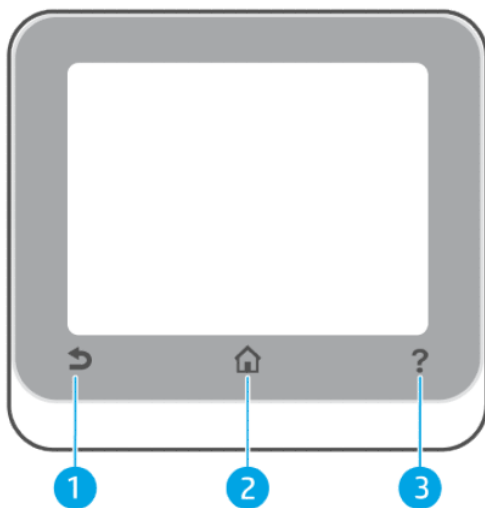

Table 1-3 Control panel

Feature	Description
1	Back button: Returns to the previous menu.
2	Home button: Access or return to the Home screen from any other screen.
3	Help button: Opens the Help menu when on the Home screen or shows contextual help content if it is available for the current operation when on other screens.

Function buttons

Table 1-4 Function buttons

Feature	Description
Quicksets	<p>Access to a list of shortcuts frequently used.</p> <p>You can create the list using the HP Smart app and save the list in the Control Panel.</p> <p>For more information about using the HP Smart app, go to:</p> <ul style="list-style-type: none">• iOS/Android: www.hp.com/go/hpsmart-help• Windows 10 and above: www.hp.com/go/hpsmartwin-help• macOS: www.hp.com/go/hpsmartmac-help
Copy	Copy document, ID card, or photo.
Scan	Scan document or photo to email, USB flash drive, network folder, SharePoint, or computer.
Print	Print from a USB flash drive.
Fax (fax models only)	Set up fax, send fax, or reprint received fax.

Dashboard icons

The Dashboard on the printer control panel lets you access the icons on the display, check the status of the printer, or monitor and manage current and scheduled printer tasks.

To open the Dashboard, touch or swipe down the tab  at the top of the screen on the control panel.

Table 1-5 Dashboard icons











Feature	Description
	Setup: Displays the setup screen for changing preferences, network setup, Wi-Fi Direct, Web Services setup, fax setup, and other maintenance settings and generating reports.
	Wi-Fi: Displays wireless status and menu options. For more information, see Change wireless settings . NOTE: Ethernet  and Wi-Fi  will not be displayed at the same time. The icon that is shown depends on the way your printer is connected to the network. If the network connection of the printer has not been set up, then the printer control panel display shows Wi-Fi  by default.
	Ethernet: Shows that an Ethernet network connection exists and provides easy access to the network status screen.
	Wi-Fi Direct: Displays the status, name, and password for Wi-Fi Direct, and the number of devices connected. You can also change settings and print a guide.
	Cartridge: Displays the estimated toner levels. NOTE: Toner level alerts and indicators provide estimates for planning purposes only. When you receive a low-on-toner alert, consider having a replacement cartridge available to avoid possible printing delays. You do not have to replace the cartridges until prompted to do so.

Table 1-5 Dashboard icons (continued)

Feature	Description
	Fax Status (fax models only): Displays status information for the Auto Answer function, fax logs, and the fax sound volume.
	HP EcoSolutions : Displays a screen where you can configure some of the printer's environmental features.

Change printer settings



Use the control panel to change the printer functions and settings, print reports, or get help for the printer.

 **TIP:** If the printer is connected to a computer, you can also change the printer settings using the EWS. See [Configure the printer using the Embedded Web Server \(EWS\)](#).

To change settings for a function



The Home screen of the control panel display shows the available functions for the printer. Some features of the functions allow you to change settings.



1. Select a desired option of a function such as touch **Copy Document** or **Scan To USB**.
2. After selecting a function, touch **Setup** , scroll through the available settings, and then touch the setting you want to change.
3. Follow the prompts on the control panel display to change the settings.

 **TIP:** Touch Home  to return to the Home screen.

To change the printer settings

To change the printer settings or print reports, use the options available on the **Setup** menu.

1. From the printer control panel, touch or swipe down the tab  at the top of the screen to open the Dashboard, and then touch **Setup** .
2. Touch and scroll through the screens.
3. Touch the screen items to select screens or options.

 **TIP:** Touch Home  to return to the Home screen.

Use the HP Smart app to print, scan, and manage

The HP Smart app can help you perform many different printer tasks, including the following:

 **NOTE:** Set up / connect the printer to the Internet using the control panel or through the HP software. You can download the HP software from hpsmart.com/setup on a Windows or Mac computer.

- Print and scan documents and photos.

- Share documents through email and other applications.
- Manage printer settings, check printer status, print reports, and order supplies.

 **NOTE:**

- HP Smart is supported on mobile devices and computers running on iOS, Android, Windows 10 and above, and macOS (versions 10.14, 10.15, 11.0, and 12).
 - The HP Smart app might not be available in all languages. Some features might not be available with all printer models.
-

To install HP Smart and open the app

Complete the following steps to install and open HP Smart, connect your printer, and begin using the app.

1. Download and install HP Smart app on your device.

 **NOTE:**

- **iOS, Android, Windows 10 and above, and macOS:** You can download HP Smart from the respective app stores for the device.
-

2. Open HP Smart after installation.

- **iOS/Android:** From the mobile device desktop or app menu, tap HP Smart.
- **Windows 10 and above:** From the computer desktop, click **Start**, and then select **HP Smart** from the app list.
- **macOS:** From the Launchpad, select HP Smart.

3. Sign in to the HP Smart app using the HP account created during setup. See [Connect your printer to a Wi-Fi network using HP software](#).

Get more information about HP Smart

To learn how to connect, print, and scan using HP Smart, visit the website for your device:

- **iOS/iPadOS/Android:** www.hp.com/go/hpsmart-help
- **Windows 10 and above:** www.hp.com/go/hpsmartwin-help
- **macOS:** www.hp.com/go/hpsmartmac-help

Set up Scan to Email

You can use the printer to scan documents and send them to one or more email addresses as attachments—without additional scanning software. You do not need to scan files from your computer and attach them to email messages.

Set the Outgoing Email Profiles

Configure the email address that appears in the FROM portion of the email message sent by the printer. You can add up to 10 Outgoing Email Profiles. You can use the HP software installed on your computer to create these profiles.

Add email addresses to the Address Book

Manage the list of people to whom you can send email messages from the printer. You can add up to 15 email addresses with their corresponding contact names. You can also create email groups. To add email addresses, you can use the printer's embedded web server (EWS) or the printer's control panel.

Configure other email options

You can configure default SUBJECT and body text that is included in all email messages sent from the printer. To configure these options, you can use the printer's EWS or the printer's control panel.

Step 1: Set up the outgoing email profiles

To set up the outgoing email profile used by the printer, complete the following steps for your operating system by using either of the following options.

From embedded web server (EWS) through the HP Printer software

1. Open the HP printer software. For more information, see [Open the HP printer software \(Windows\)](#).
2. Click **Print, Scan & Fax** and then click **Scan**.
3. Click **Scan to E-mail Wizard**.

(OR)

From embedded web server (EWS) through web browser

1. Open the embedded web server (EWS). For more information, see [Configure the printer using the Embedded Web Server \(EWS\)](#).
2. On the **Home** tab, click **Scan to Email**.
3. Click , and then follow the onscreen instructions.
4. After you have entered the required information about the outgoing email settings, click **Save and Test** to make sure the outgoing email is working correctly. The entry is added to the **Outgoing Email Profiles** table.

Step 2: Add email addresses to the Address Book

1. Open the embedded web server (EWS). For more information, see [Configure the printer using the Embedded Web Server \(EWS\)](#).
2. Select the **Scan** tab, from the left menu click **Address Book**, and then click **Contacts**.
3. Click  to add a single email address.

-Or-

Click  to create an email distribution list.

 **NOTE:** Before you can create an email distribution list, you must have already added at least one email address to the Address Book.

4. Follow the onscreen instructions. The entry is added to the **Contacts Stored on the Printer** table.

 **NOTE:** Contact names appear on the printer's control panel display and in your email application.

Step 3: Configure other email options



To configure other email options (such as configuring default SUBJECT and body text that is included in all email messages sent from the printer, as well as scan settings used when sending email from the printer), complete the following steps:

1. Open the embedded web server (EWS). For more information, see [Configure the printer using the Embedded Web Server \(EWS\)](#).
2. On the **Scan** tab, click **Scan to Email**, and then click **Default Settings**.
3. Change any settings, and then click **Apply**.

2 Connect your printer

This section describes different ways to connect your printer.

Connect your printer to a Wi-Fi network using Control Panel

1. From the top of the screen, touch or swipe down the tab  to open the Dashboard and touch **Setup** .
2. Touch **Network Setup**.
3. Touch **Wireless Settings**, and then touch **Wireless setup Wizard**.
4. Follow the onscreen instructions to connect your printer to the Wi-Fi network.
5. The control panel displays the status of the Wi-Fi icon.

Connect your printer to a Wi-Fi network using HP software

Install the HP software on your computer and use it to set up or connect the printer to your Wi-Fi network.

 **NOTE:** This section is applicable to wireless printers only.

For information about HP software including where to download it, visit hpsmart.com/setup.



1. Make sure your computer is connected to the same Wi-Fi network that the printer will be connected to.
2. Turn on the printer's Wi-Fi. For more information about wireless status, see [Change wireless settings](#).
3. If the printer is no longer in wireless setup mode, restore the printer network settings. See [Restore original factory defaults and settings](#).
4. Download and run HP software from hpsmart.com/setup on your device.
5. From the HP software, find your printer and click **Continue**.
6. Follow the onscreen instructions and connect the printer to the Wi-Fi network.
7. Once the printer is connected to the Wi-Fi network, follow the instructions for applying proxy settings and updating the firmware.
8. When prompted on the printer's control panel touch **Allow** to display the pairing code.
9. Click **Launch Portal** from the HP software to visit hpsmart.com/connect.
10. At the portal, follow the instructions to create/sign in with an account and connect your printer to your account.

Connect your printer to a Wi-Fi network using Wi-Fi Protected Setup (WPS)

This topic describes how to connect your printer to a Wi-Fi network using WPS.

 **NOTE:** This section is applicable to wireless printers only.

This wireless setup method can be used if your router has a WPS button. If the router does not have this button, it is recommended that you connect the printer using HP software. See [Connect your printer to a Wi-Fi network using HP software](#).

1. From the printer control panel, touch or swipe down the tab  at the top of the screen to open the Dashboard, and then touch **Setup** .
2. Touch **Network Setup**.
3. Touch **Wireless Settings**.
4. Touch **Wireless Setup Wizard** or **Wi-Fi Protected Setup**.
5. Follow the display instructions to complete the setup.

 **NOTE:** When the printer is idle for long, you might be prompted to enter the PIN, which is available from a label in the cartridge access area. See [Things to note when accessing EWS](#).

Connect your printer to an Ethernet network

This topic describes how to connect your printer to an Ethernet network.

If your Ethernet network does not have an Internet connection, connect the printer wirelessly to the HP software. See [Connect your printer to a Wi-Fi network using HP software](#).

1. Make sure your computer is connected to the router.
2. Connect your printer and router using an Ethernet cable. (Ethernet cable sold separately.)

 **NOTE:**

- The Wi-Fi connection is automatically disabled when you connect the Ethernet cable.
 - To connect the printer wirelessly, disconnect the Ethernet cable and connect the printer to your wireless network using HP software. See [Connect your printer to a Wi-Fi network using HP software](#).
-
3. From the HP software, find your printer and click **Continue**. Follow onscreen instructions to add the printer to your network.
 4. Click **Launch Portal** to visit hpsmart.com/connect.
 5. At the portal, follow the instructions to create/sign in with an account and connect your printer to your account.

Connect your printer using a USB cable

1. If necessary, remove the label covering the USB port at the back of the printer.



2. Connect the printer and computer using a USB cable.
3. From the HP software, find your printer and click **Continue**. Follow the onscreen instructions to add the printer to your network.

Change wireless settings

You can set up and manage the wireless connection for your printer. This includes printing information about network settings, turning the wireless function on or off, and restoring wireless settings.

Turn on or off the wireless capabilities of the printer

 **NOTE:** Connecting an Ethernet cable to the printer automatically turns off the wireless capability and the Wi-Fi icon's display.

1. From the printer control panel, touch or swipe down the tab  at the top of the screen to open the Dashboard, touch **Setup** , and then touch **Network Setup**.
2. Touch **Wireless Settings**.
3. Touch the toggle button next to **Wireless** to switch it on or off.

 **NOTE:** If the printer has never been configured to connect to a wireless network before, turning on the wireless capability automatically starts the Wireless Setup Wizard.

Change the connection type

This topic describes how to change the way to connect your printer.

Change USB to a wireless connection (Windows 7/Windows 10 and above/macOS)

1. Unplug the USB cable from the printer.
2. Make sure the computer or mobile device is connected to your Wi-Fi network and Bluetooth is turned on.
3. Make sure your printer has Wi-Fi turned on. See [Change wireless settings](#).
4. Put the printer in wireless setup mode by restoring the printer network settings. See [Restore original factory defaults and settings](#).
5. From the HP software, find your printer and click **Continue**. Follow the instructions to add the printer to your network.
6. If prompted, click on **Launch Portal** to visit hpsmart.com/connect.
7. At the portal, follow the instructions to create/sign in with an account and connect your printer to your account.

Change wireless to a USB connection (Windows/macOS)

1. If necessary, remove the label covering the USB port at the back of the printer.
2. Connect the printer and computer using a USB cable.

3. From the HP software, find your printer and click **Continue**. Follow the instructions to add the printer to your network.

3 Load media

This section describes how to load different media into your printer.

Before you begin

 **NOTE:**

- To protect the printer and avoid printing problems, be sure to select the correct paper settings from the HP software before printing.
 - For the tray capacity and list of supported paper sizes, visit hp.com/support. Select your country/region and language, find your printer, click **Product Information**, and check the product specifications for your printer. To avoid paper jams:
 - Never add or remove paper from the input tray during printing.
 - If there is other paper in the input tray, remove the paper before loading a different paper type or size.
 - When loading the tray, do not fan the paper.
 - Use paper that is not wrinkled, folded, or damaged.
 - Use only one paper size. For example, do not place A5 paper over A4 size paper.
 - Straighten the stack of paper and adjust the paper guides to ensure paper does not slant/skew when printing.
-

Load paper

This topic describes how to load paper into the input tray.

1. Open the input tray.

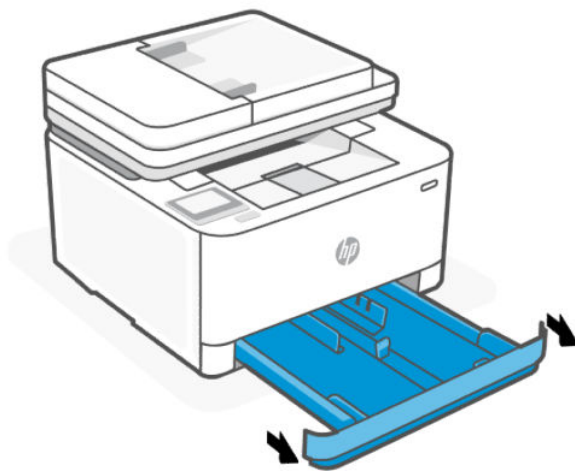

2. If you are loading Legal or longer paper, press the button near the front right of the tray to extend the input tray.

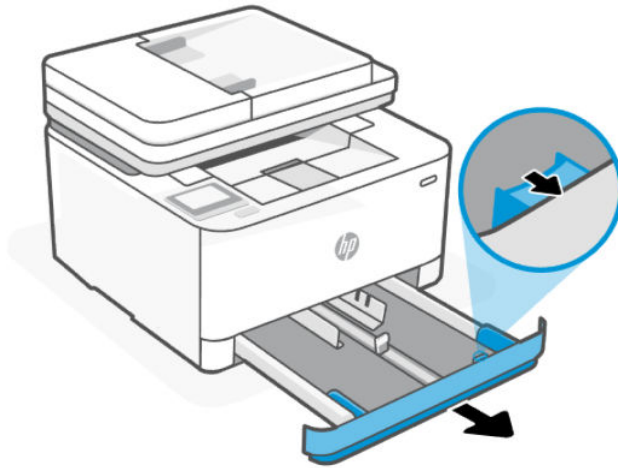

3. Press and hold the button on one of the paper-width guides and slide the guides to the edges of the input tray. Do the same for the paper-length guide.

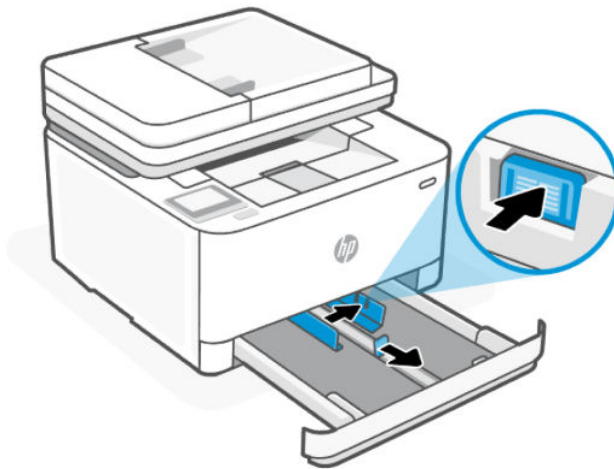

4. Insert the paper in portrait orientation and with the side to be printed facing up.

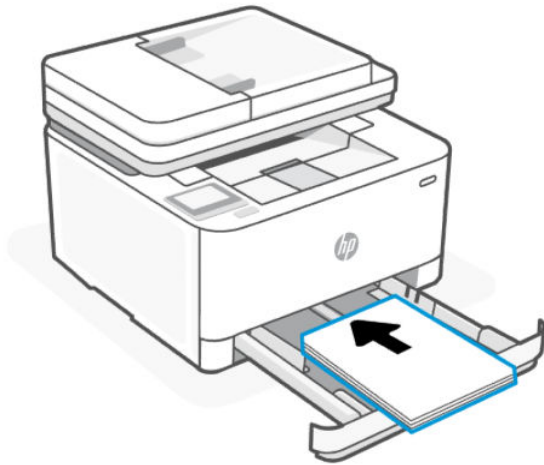

Make sure the stack of paper is aligned with the appropriate paper size lines in the tray. Also, make sure the stack of paper does not exceed the stack height marking in the tray.

5. Adjust the paper-width guides and paper-length guide until they touch the edges of the stack of paper.

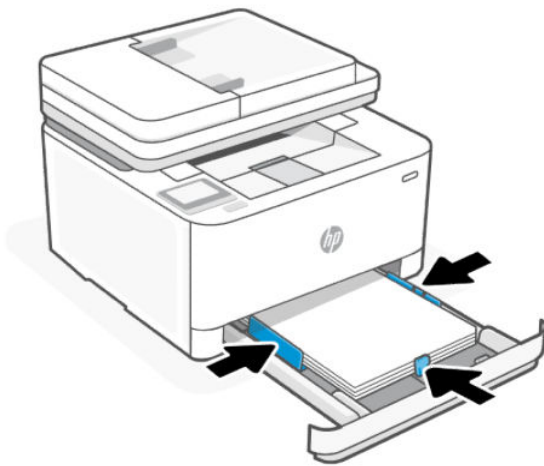

6. Close the input tray.

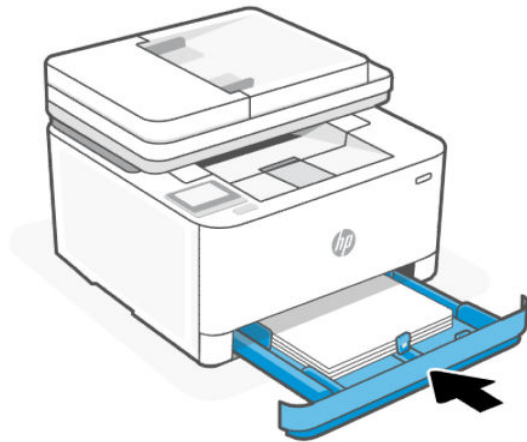

7. Open the output tray extender.

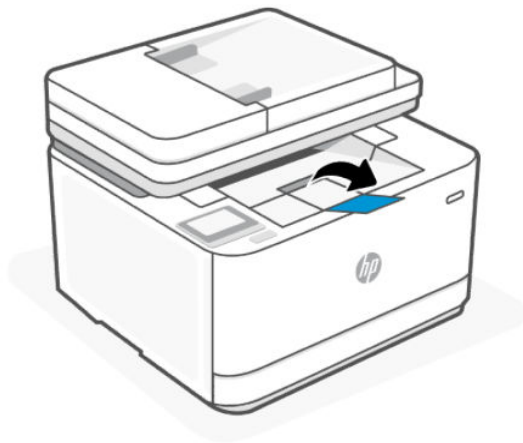

Load envelopes

This topic describes how to load an envelope into the input tray.

1. Open the input tray.
2. Slide the paper guides to the edges of the input tray.
3. Insert the envelopes in portrait orientation and with the side to be printed facing up.

Make sure the stack of envelopes is aligned with the appropriate paper size lines in the tray. Also, make sure the stack of envelopes does not exceed the stack height marking in the tray.

4. Adjust the paper guides until they touch the edges of the stack of envelopes.

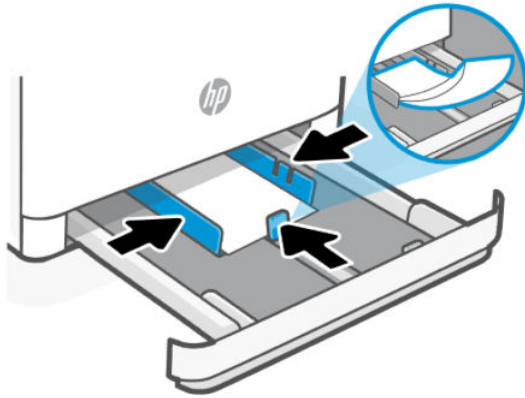

5. Close the input tray.
6. Open the output tray extender.

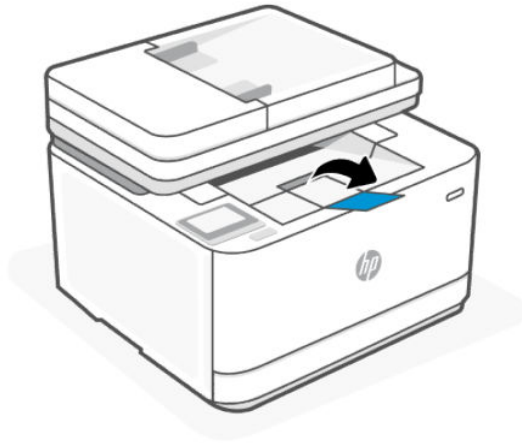

Load labels

This topic describes how to load labels into the input tray.

1. Open the input tray.
2. Remove all paper from the input tray.
3. Slide the paper guides to the edges of the input tray.
4. Insert the sheet of labels in portrait orientation and with the side to be printed facing up.

5. Adjust the paper guides until they touch the edges of the sheet of labels.

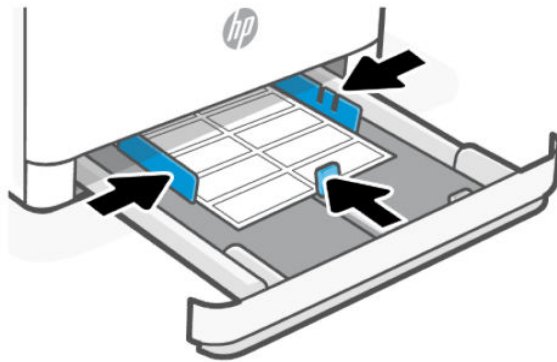

6. Close the input tray.
7. Open the output tray extender.



Load an original on the scanner glass

You can copy or scan originals by loading them on the scanner glass.

 **NOTE:** The scanner might not work correctly if the scanner glass and lid backing are not clean.

1. Lift the scanner lid.



2. Load your original print-side down and align it with the marking on the rear-left corner of the glass.

 **TIP:** For more help on loading an original, refer to the engraved guides along the edge of the scanner glass.



3. Close the lid.

Load an original in the document feeder

You can copy or scan a document by placing it in the document feeder.

CAUTION: Do not load photos in the document feeder, this might cause damage to your photos. Use only paper that is supported by the document feeder.

NOTE: Some features, such as the **Fit to Page** copy feature, do not work when you load your originals in the document feeder. For those features to work, load your originals on the scanner glass.

1. Open the output tray extender.

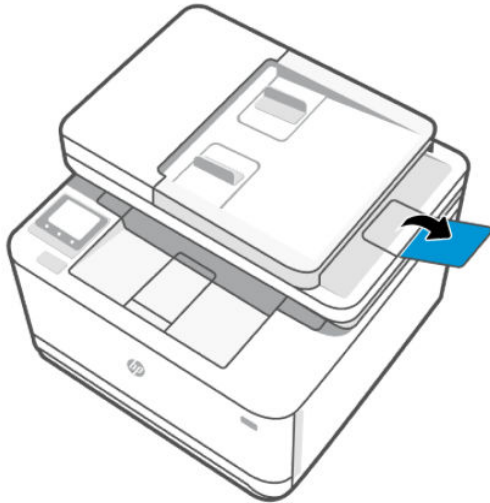

2. Slide the paper-width guides to the edges of the document feeder.



3. Load your original print-side up into the document feeder.

Slide the paper into the document feeder until you hear a tone or see a message on the printer control panel display indicating that the loaded pages were detected.

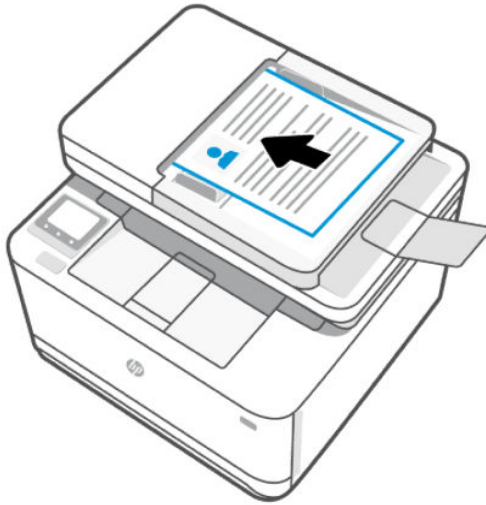

4. Adjust the paper-width guides until they touch the edges of the paper.



Change the paper settings

When prompted during paper loading, change the paper settings on the printer control panel or HP software to match the paper you are using.

To change the paper settings (Windows)

1. From the software program, select the **Print** option.
2. Select the printer, and then click the **Set Preferences** button.
3. Change the paper size and type to match the paper loaded in the input tray.
4. Make sure the paper guides in the tray are adjusted correctly for the size of paper.

To change the paper settings (OS X)

1. Click the **File** menu, and then click the **Print** option.
2. In the **Printer** menu, select the printer.
3. Change the paper size and type to match the paper loaded in the input tray.
4. Make sure the paper guides in the tray are adjusted correctly for the size of paper.

To change the default paper settings from the embedded web server

1. Open the EWS. See [Configure the printer using the Embedded Web Server \(EWS\)](#).
2. Click the **Settings** tab.
3. From the left menu, click **Preferences**.
4. Click **Tray and Paper Management**, and then make the necessary changes.
5. Click **Apply**.

4 Print

This section describes how to print from different devices.

To protect the printer and avoid printing problems, be sure to select the correct paper settings from the HP software before printing.

 **NOTE:**

- To provide productive printing, this printer may automatically enter cool-down mode under certain environmental conditions. When the printer is cooling down, printing might pause for a few minutes. A relevant message also appears on the printer control panel, printer software, or HP Smart app.
 - Before printing documents, make sure you have the paper loaded in the input tray and the output tray extender is open. See [Load paper](#) for details.
-

Print with mobile devices

This topic describes how to print from mobile devices.

You can use the HP Smart app to print documents and photos that you have imported or created within the app. See [Use the HP Smart app to print, scan, and manage](#).

You can also print directly from your mobile devices using AirPrint (iOS) or HP Print Service Plugin (Android):

- **iOS:** Devices running iOS 4.2 or later have AirPrint pre-installed.
- **Android:** Download the HP Print Service Plugin from the Google Play Store or your favorite app store, and then enable it on your device.

 **NOTE:** You can print using HP Smart or AirPrint/HP Print Service Plugin when the mobile device is on the same network as the printer or a different network (using Wi-Fi Direct).

Print while connected to same Wi-Fi network

You can print documents and photos from your mobile device when the device is on the same Wi-Fi network as the printer.

Visit www.hp.com/go/mobileprinting for more information on mobile printing.

 **NOTE:** Make sure your mobile device and printer are connected to the same Wi-Fi network. See [Connect your printer to a Wi-Fi network using HP software](#).

Print without connecting to same Wi-Fi network (Wi-Fi Direct)



With Wi-Fi Direct, you can directly connect your computer or mobile device to the printer and print wirelessly—without connecting your computer or mobile device to an existing wireless network.

Visit www.hp.com/go/wifidirectprinting for more information on Wi-Fi Direct.

 **NOTE:**

- Make sure Wi-Fi Direct on your printer is turned on. To check, open the EWS (see [Configure the printer using the Embedded Web Server \(EWS\)](#)), click the **Network** tab, and then select **Wi-Fi Direct**.
 - Up to 5 computers and mobile devices can connect to the printer using Wi-Fi Direct connection.
-

To turn Wi-Fi Direct on or off from the printer control panel

1. On the Home screen of the printer display, touch or swipe down the tab  at the top of the screen to open the Dashboard, and then touch Wi-Fi Direct .
2. Touch **Setup** .
3. If Wi-Fi Direct is **off**, touch the toggle button next to Wi-Fi Direct to switch it on or off.

To find the Wi-Fi Direct name or password

On the Home screen of the printer display, touch Wi-Fi Direct  to display Wi-Fi Direct name or password.

Print using a Windows computer

1. Make sure you have installed the HP Smart app and added the printer to it. See [Use the HP Smart app to print, scan, and manage](#).
2. Open the document you wish to print.
3. From the **File** menu in your software program, select the **Print** option.
4. Click the button that opens the **Properties** dialog box.
Depending on your software application, this button might be called **Properties**, **Options**, **Setup**, or **Preferences**.
5. Make sure your printer is selected.
6. Change any print settings and click **OK**.
7. Click **Print** or the **OK** button to print the job.

Print from a Mac computer

1. Make sure you have installed the HP Smart app and added the printer to it. See [Use the HP Smart app to print, scan, and manage](#).
2. Once connected, open the document you wish to print and use the **Print** command.
3. Make sure the desired printer is selected.
4. Change any print settings.
5. Click **Print** to print the document.

5 Copy, Scan, and Mobile Fax

This section describes the copy, scan, and mobile fax features.

Copy

This topic describes how to create a copy of your original.

To copy document or ID card

1. Make sure you have paper loaded in the input tray. For more information, see [Load paper](#).
2. Place your original print-side down on the scanner glass or print-side up in the document feeder.
3. From the printer control panel display, touch **Copy**.
4. Select **Document** or **ID Card**.
5. Enter the number of copies by using the keypad or make changes to other settings.

 **TIP:** To save your settings as defaults for future jobs, touch **Copy Settings** , and then touch **Save Current Settings**.

6. Touch **Copy** .

Scan

You can scan documents, photos, and other paper types, and send them to a variety of destinations, such as a computer or an email recipient.

When scanning documents with the HP printer software, you can scan to a format that can be searched and edited.

When scanning a borderless original, use the scanner glass and not the document feeder.

 **TIP:** Sign up for HP Smart Advance to experience premium HP Smart service such as scan documents as editable text. For more information, see hpsmart.com.

Scan to a computer

Before scanning to a computer, make sure you have already installed the HP recommended printer software. The printer and computer must be connected and turned on.

In addition, on Windows computers, the printer software must be running prior to scanning. See [Open the HP printer software \(Windows\)](#).

You can use the HP printer software to scan documents into editable text.

To scan an original to a computer from the printer control panel

Please make sure the printer is already connected to the computer before scanning.

1. Load your original print-side down on the scanner glass or print-side up in the document feeder.
2. Touch **Scan** from the control panel, and then select **Computer**.
3. Select your computer name.
4. Touch **Send** .

To enable the scan to a computer feature (Windows)

If the printer is connected to the computer with a USB connection, the feature for scanning to computer is enabled by default and cannot be disabled.

If you are using network connection, follow these instructions if the feature has been disabled, and you wish to enable it again.

1. Open the HP printer software. For more information, see [Open the HP printer software \(Windows\)](#).
2. Click **Print, Scan & Fax**, and then click **Scan**.
3. Select **Manage Scan to Computer**.
4. Click **Enable**.

Scan to a memory device

You can scan directly to a USB flash drive from the printer control panel without using a computer or the HP printer software.

 **CAUTION:** Do not remove the flash drive from the printer USB port while it is being accessed by the printer. This can damage the files on the USB flash drive. You can safely remove a USB flash drive only when the USB port light is not blinking.

 **NOTE:** The printer does not support encrypted USB flash drives.

You can also use the HP Smart or the HP printer software to scan documents into editable text. Subscription may be required.

To scan an original to a memory device from the printer control panel

1. Load your original print-side down on the scanner glass or print-side up in the document feeder.
2. Insert a USB flash drive.
3. Touch **Scan**, and then select **USB**.
4. Make changes to scan options, if needed.
5. Touch **Send** .

Set up HP Digital Solutions

You can set up HP Digital Solutions using software wizards that you can open from the HP printer software (Windows 7).

You can also use the printer's embedded web server (EWS) to set up the HP Digital Solutions. For more information about using the EWS, see [Configure the printer using the Embedded Web Server \(EWS\)](#).

 **NOTE:** If you are using the printer in an IPv6-only network environment, you must set up the digital solutions using the EWS.

Set up HP Digital Filing

To set up HP Digital Filing, follow the appropriate instructions.

 **NOTE:** You can also use these steps to change settings in the future.

Set up Scan to Network Folder

You can configure up to 10 destination folders for each printer using either of the following options.

 **NOTE:** To use Scan to Network Folder, you must have created and configured the folder you are using on a computer connected to the network. You cannot create a folder from the printer's control panel. Also, make sure the folder preferences are set to provide read and write access. For more information about creating folders on the network and setting folder preferences, see the documentation for your operating system.

After you finish setting up Scan to Network Folder, the HP software automatically saves the configurations to the printer.

From embedded web server (EWS) through the HP Printer software

1. Open the HP printer software. For more information, see [Open the HP printer software \(Windows\)](#).
2. Click **Scan** under **Print, Scan & Fax**.
3. Click **Scan to Network Folder Wizard**.

(OR)

From embedded web server (EWS) through web browser

1. Open the embedded web server (EWS). For more information, see [Configure the printer using the Embedded Web Server \(EWS\)](#).
2. On the **Scan** tab, click **Scan to Network Folder**.
3. From the left menu, select **Quick Sets** and click plus sign (+) and follow the onscreen instructions to create new Quick Sets.

 **NOTE:** You can customize the scan settings for each destination folder.

4. After you have entered the required information about the network folder, click **Apply and Test** to make sure the link to the network folder is working correctly. The entry is added to the table under the **Quick Sets Settings** page.

Scan to SharePoint



This topic describes how to scan documents to SharePoint.

To set up Scan to SharePoint from embedded web server (EWS)

1. Open the embedded web server (EWS). For more information, see [Configure the printer using the Embedded Web Server \(EWS\)](#).

2. On the **Scan** tab, click **Scan to SharePoint**.
3. From the left menu, select **Quick Sets** and click plus sign (+) and follow the onscreen instructions to create new Quick Sets.
4. After you have entered the required information about SharePoint, click **Apply and Test** to make sure the link to SharePoint is working correctly. The entry is added to the table under the **Quick Sets Settings** page.

To scan to SharePoint from the Control Panel

1. Load your original print-side down on the scanner glass or print-side up in the document feeder.
2. From Home screen, touch **Scan**, and then touch **SharePoint**.
3. Touch **File Name** to enter the name of the file to be scanned, and then touch **Done**.
4. Touch **Setup**  to change the scan settings.
5. Touch **Preview**  if you want to preview the scanned document.
6. Touch **Send**  to save the document in SharePoint.
7. Touch **Finish** when the scan completes or touch **Add Page** to add another page.

Scan to email

This topic describes different options to scan and email.

Scan to email through Scan function

You need to set up email addresses first, and then scan and email your documents.





NOTE: You need a network-connected computer to set up Scan to Email.

1. From Home screen, touch **Scan**, and then touch **Email**.
2. On the **Email Profile Not Set Up** screen, touch **Next**.
3. Touch **Using the HP Software Installed on a Computer** or **Using a Web Browser**, and then follow the onscreen message to set up email profile.

For more information, see [Set up Scan to Email](#).

Email the scanned document or photo

1. Load your original print-side down on the scanner glass or print-side up in the document feeder.
2. From Home screen, touch **Scan**, and then touch **Email**.
3. Confirm the email account that you want to use, and touch **Continue**.
If you want to change email account, touch **Address Book** , select the email account you want to use, and then touch **Continue**.
4. Enter recipient's email address in the **To** field.
Or touch **Address Book** , select the email account you want to send to, and then touch **Continue**.

5. Enter email subject in the **Subject** field.
6. Touch **Preview**  if you want to preview scanned photo or document.

Touch **Scan Settings**  to change the settings.
7. Touch **Send**.
8. Touch **Finish** when the scan completes or touch **Add Page** to add another page.

Scan using HP Smart (iOS/Android, Windows 10 and above, and macOS)

You can use the HP Smart app to scan documents or photos from the printer's scanner, and you can also scan using your device camera. HP Smart includes editing tools that allow you to adjust the scanned image before saving or sharing. You can print, save your scans locally or in cloud storage, and share them via email, SMS, Facebook, Instagram, etc. To scan with HP Smart, follow the instructions provided in the appropriate section below, depending on the type of device you are using.

- **iOS/Android:** www.hp.com/go/hpsmart-help
- **Windows 10 and above:** www.hp.com/go/hpsmartwin-help
- **macOS:** www.hp.com/go/hpsmartmac-help

Scan using the HP Scan software (Windows 7)

Use the HP Scan software to initiate scanning from software on your computer. You can save the scanned image as a file or send it to another software application.

 **NOTE:** Windows 7 Service Pack1 (SP1) is required to install the HP Scan software.

1. Load the document on the scanner glass according to the indicators on the printer.
2. Open the HP Printer software. From the computer desktop, click **Start**, select **All Programs**, click **HP**, click the folder for the printer, and then select the printer name.
3. Select **Scan**, and then select **Scan a Document or Photo**.
4. Adjust the settings if necessary.
5. Click **Scan**.

Scan using Webscan

Webscan is a feature of the embedded web server that lets you scan photos and documents from your printer to your computer using a web browser.

This feature is available even if you did not install the printer software on your computer.

For more information, see [Configure the printer using the Embedded Web Server \(EWS\)](#).

 **NOTE:** By default, Webscan is off. You can enable this feature from the EWS.

If you are unable to open Webscan in the EWS, your network administrator might have turned it off. For more information, contact your network administrator or the person who set up your network.

To enable Webscan

1. Open the embedded web server. For more information, see [Configure the printer using the Embedded Web Server \(EWS\)](#).
2. Click the **Settings** tab.
3. From the left menu, click **Security**, and then select **Administrator Settings**.
4. Select **Webscan from EWS** to enable Webscan.
5. Click **Apply**.

To scan using Webscan

Scanning using Webscan offers basic scan options. For additional scan options or functionality, scan from the HP printer software.

1. Load your original print-side down on the scanner glass or print-side up in the document feeder.
2. Open the embedded web server. For more information, see [Configure the printer using the Embedded Web Server \(EWS\)](#).
3. Click the **Scan** tab.
4. From the left menu, click **Scan to Computer**, and then select **Webscan**.
5. Change any required settings and then click **Start Scan**.

 **TIP:** To scan documents as editable text, you must install the HP printer software.

Tips for copy and scan success

For other scan tasks such as scan as editable text (OCR), visit hp.com/support

Mobile Fax

Use the HP Smart app to quickly scan and fax multiple pages at once from your mobile device or computer.

For more information about Mobile Fax, visit the [HP Smart website](#).

Use Mobile Fax in the HP Smart app

1. Make sure your mobile device or computer are connected to a network. Launch the HP Smart app and sign into or create your HP account.
2. Select the Mobile Fax tile.
If you do not see the **Mobile Fax** tile, enable it as follows:
 - On a mobile device: Tap **Personalize Tiles**, tap the **Mobile Fax** toggle to enable the tile, and then go back to the Home screen.
 - On Windows 10 and above devices: Click the **Settings**, select **Personalize Tiles**, and click the **Mobile Fax** toggle to enable the tile. Then, go back to the Home screen.

- On a Mac device: From the menu bar, select **HP Smart >Personalize Tiles**. Set the Mobile Fax option to **On**.



NOTE: Mobile Fax is available in specific countries/regions. If you do not see a Mobile Fax option in the Personalize Menu, Mobile Fax might not be available in your country/region.

3. Fill out the necessary mobile fax information.
4. To add a cover page, tap the **Add a cover page** toggle, and then type a subject and message.
5. Scan the item you want to fax using your printer or mobile device camera, or attach a supported file type. Send the fax when ready.

Your fax will be securely delivered and you can track the status in the HP Smart app.

6 Fax

You can use the printer to send and receive faxes. You can schedule faxes to be sent later within 24 hours and set up phone book contacts to send faxes quickly and easily to frequently used numbers. From the printer control panel, you can also set a number of fax options, such as resolution and the contrast between lightness and darkness on the faxes you send.

 **NOTE:**

- Before you begin faxing, make sure you have set up the printer correctly for faxing. You can verify the fax is set up correctly by running the fax setup test from the printer control panel.
 - This section is applicable only for models that have fax enabled.
-

Send a fax

You can send a fax in a variety of ways, depending on your situation or need.

Send a standard fax

You can send a single-page fax or multiple-page fax from the printer control panel.

 **NOTE:** Send single-page faxes by placing the original on the glass. Send multiple page faxes using the document feeder.

 **NOTE:** If you need printed confirmation that your faxes were successfully sent, fax confirmation must be enabled.

To send a standard fax from the printer control panel

1. Load your original print-side down on the scanner glass or print-side up in the document feeder.
2. From the printer control panel display, touch **Fax**.
3. Touch **Send Now**.
4. Enter the fax number by using the keypad or by selecting from the phone book.

 **TIP:** To add a pause in the fax number you are entering, touch ***** repeatedly, until a dash (-) appears on the display.

5. Touch **Send** .

If the printer detects an original loaded in the document feeder, it sends the document to the number you entered.

 **TIP:** If the recipient reports issues with the quality of the fax, try changing the resolution or contrast of your fax.

Send a standard fax from the computer

You can fax a document directly from your computer without printing it first.

To use this feature, make sure you have installed the HP printer software on your computer, the printer is connected to a working telephone line, and the fax function is set up and functioning correctly.

To send a standard fax from the computer (Windows)

1. Open the document on your computer that you want to fax.
2. On the **File** menu in your software application, click **Print**.
3. From the **Name** list, select the printer that has “**fax**” in the name.
4. To change settings, click the button that opens the **Properties** dialog box. Depending on your software application, this button might be called **Properties**, **Options**, **Printer Setup**, **Printer**, or **Preferences**.
5. After you have changed any settings, click **OK**.
6. Click **Print** or **OK**.
7. Enter the fax number and other information for the recipient, change any further settings for the fax, and then click **Send Fax**. The printer begins dialing the fax number and faxing the document.

Send a fax from a phone

You can send a fax using your telephone extension. This allows you to talk with the intended recipient before sending the fax.

To send a fax from an extension phone

1. Load your original print-side down on the scanner glass or print-side up in the document feeder.
2. Dial the number by using the keypad on the phone that is connected to the printer.

If the recipient answers the telephone, inform the recipient that they should receive the fax on their fax machine after they hear fax tones. If a fax machine answers the call, you will hear fax tones from the receiving fax machine.

3. From the printer control panel display, touch **Fax**.
4. Touch **Send Now**.
5. When you are ready to send the fax, touch **Send** .

The telephone is silent while the fax is transmitting. If you want to speak to the recipient later, remain on the line until the transmission is complete. If you were finished talking to the recipient, you can hang up the telephone as soon as the fax begins transmitting.

Send a fax using monitor dialing



When you send a fax using monitor dialing, you can hear the dial tones, telephone prompts, or other sounds through the speakers on the printer. This enables you to respond to prompts while dialing, as well as control the pace of your dialing.

 **TIP:** If you are using a calling card and do not enter your PIN fast enough, the printer might start sending fax tones too soon and cause your PIN not to be recognized by the calling card service. If this is the case, create a phone book contact to store the PIN for your calling card.

 **NOTE:** Make sure the volume is turned on to hear a dial tone.

To send a fax using monitor dialing from the printer control panel

1. Load your original print-side down on the scanner glass or print-side up in the document feeder.
2. From the printer control panel display, touch **Fax**.
3. Touch **Send Now**.
4. Touch  **Send**.
5. When you hear the dial tone, enter the number by using the keypad on the printer control panel.
6. Follow any prompts that might occur.

 **TIP:** If you are using a calling card to send a fax and you have your calling card PIN stored as a phone book contact, when prompted to enter your PIN, touch **Phone Book** , and then touch **Local Phone Book** to select the phone book contact where you have your PIN stored.

Your fax is sent when the receiving fax machine answers.

Send a fax using printer memory

You can scan a black-and-white fax into memory and then send the fax from memory. This feature is useful if the fax number you are trying to reach is busy or temporarily unavailable. The printer scans the originals into memory and sends them once it is able to connect to the receiving fax machine. After the printer scans the pages into memory, you can immediately remove the originals from the document feeder tray or scanner glass.

 **NOTE:** You can only send a black-and-white fax from memory.

 **NOTE:** You can scan multiple pages from the scanner glass to the printer's memory, and then fax them. You can use this feature to fax multiple pages from a book or magazine, when it is not feasible in ADF.

To send a fax using printer memory

1. Ensure that **Scan and Fax Method** is turned on.
 - a. From the printer control panel display, touch **Fax**.
 - b. Touch **Setup**, and then touch **Preferences**.
 - c. Touch **Scan and Fax Method** to turn it on.
2. Load your original print-side down on the scanner glass or print-side up in the document feeder.
3. From the printer control panel display, touch **Fax**.

4. Touch **Send Now**.
5. Enter the fax number by using the keypad.

Or touch **Phone Book** , and then touch **Local Phone Book** or **Call History** to select a number or group to dial.





6. Touch **Send** .

The printer scans the originals into memory and sends the fax when the receiving fax machine is available.

Send a fax to multiple recipients

You can send a fax to multiple recipients by creating a group phone book contact made up of two or more individual recipients.

To send a fax to multiple recipients using group phone book

1. Load your original print-side down on the scanner glass or print-side up in the document feeder.
2. From the printer control panel display, touch **Fax**.
3. Touch **Send Now**.
4. Touch **Phone Book** , and then touch **Local Phone Book**.
5. Touch **Phone Book**  and select **Group**  to switch to the group phone book.
6. Touch the name of the group that you want to send.
7. Touch **Send** .

Printer sends the document to all the numbers in the selected group.

 **TIP:** If the recipient reports issues with the quality of the fax, try changing the resolution or contrast of your fax.

Send a fax in Error Correction Mode

Error Correction Mode (ECM) prevents loss of data due to poor phone lines by detecting errors that occur during transmission and automatically requesting retransmission of the erroneous portion. Phone charges are unaffected, or might even be reduced, on good phone lines. On poor phone lines, ECM increases sending time and phone charges, but sends the data much more reliably. The default setting is **On**. Turn ECM off only if it increases phone charges substantially, and if you can accept poorer quality in exchange for reduced charges.

If you turn ECM off:

- The quality and transmission speed of faxes you send and receive are affected.
- The **Speed** is automatically set to **Medium**.

To change the ECM setting from the control panel

1. From the printer control panel display, touch **Fax**.
2. Touch **Setup**.

3. Touch **Preferences**.
4. Scroll to **Error Correction Mode** to touch to turn the feature on or off.

Receive a fax

You can receive faxes automatically or manually. If you turn off the **Auto Answer** option, you must receive faxes manually. If you turn on the **Auto Answer** option (the default setting), the printer automatically answers incoming calls and receives faxes after the number of rings that are specified by the **Rings to Answer** setting. (The default **Rings to Answer** setting is five rings.)

If you receive a Legal-size or larger fax and the printer is not currently set to use Legal-size paper, the printer reduces the fax so that it fits on the paper that is loaded. If you have disabled the **Automatic Reduction** feature, the printer prints the fax on two pages.



NOTE: If you are copying a document when a fax arrives, the fax is stored in the printer memory until the copying finishes.

Receive a fax manually

When you are on the phone, the person you are speaking with can send you a fax while you are still connected. You can pick up the handset to talk or listen for fax tones.

You can receive faxes manually from a phone that is directly connected to the Fax port  on the back of the printer.

To receive a fax manually

1. Make sure the printer is turned on and you have paper loaded in the input tray.
2. Remove any originals from the document feeder tray.
3. Touch **Fax, Setup, and Preferences**.
4. Scroll down the options and set the **Rings to Answer** setting to a high number to allow you to answer the incoming call before the printer answers. Or, turn off the **Auto Answer** setting so that the printer does not automatically answer incoming calls.
5. If you are currently on the phone with the sender, instruct the sender to press **Send** on their fax machine.
6. Do the following when you hear fax tones from a sending fax machine.
 - a. From the printer control panel display, touch **Accept** to receive the fax.
 - b. After the printer begins to receive the fax, you can hang up the phone or remain on the line. The phone line is silent during fax transmission.

Set up backup fax

Depending on your preference and security requirements, you can set up the printer to store all the faxes it receives, only the faxes it receives while the printer is in an error condition, or none of the faxes it receives.

To set backup fax from the printer control panel

1. From the printer control panel display, touch **Fax**.
2. Touch **Setup**.

3. Touch **Preferences**.
4. Touch **Backup Fax Reception**.
5. Touch the required setting.

Settings	Description
On	<p>The default setting. When Backup fax is On, the printer stores all received faxes in memory. This enables you to reprint up to 30 of the most recently printed faxes if they are still saved in memory.</p> <p>NOTE: When printer memory is low, it overwrites the oldest printed faxes as it receives new faxes. If the memory becomes full of unprinted faxes, the printer stops answering incoming fax calls.</p> <p>NOTE: If you receive a fax that is too large, such as a very detailed color photo, it might not be stored in memory due to memory limitations.</p>
On Error Only	<p>Causes the printer to store faxes in memory only if an error condition exists that prevents the printer from printing the faxes (for example, if the printer runs out of paper). The printer continues to store incoming faxes as long as there is memory available. If the memory becomes full, the printer stops answering incoming fax calls. When the error condition is resolved, the faxes stored in memory print automatically, and then they are deleted from memory.</p>
Off	<p>Faxes are never stored in memory. For example, you might want to turn off Backup fax for security purposes. If an error condition occurs that prevents the printer from printing (for example, the printer runs out of paper), the printer stops answering incoming fax calls.</p>

Reprint received faxes from memory

The received faxes that are not printed are stored in memory.

 **NOTE:** After the memory becomes full, the printer cannot receive the new fax until you print or delete the faxes from memory. You might also want to delete the faxes in memory for security or privacy purposes.

You can reprint up to 30 of the most recently printed faxes if they are still in memory. For example, you might need to reprint your faxes if you lost the copy of your last printout.

To reprint faxes in memory from the printer control panel

1. Make sure you have loaded paper in the input tray. For more information, see [Load paper](#).
2. From the printer control panel display, touch **Fax**.
3. Touch **Reprint**.

The faxes are printed in the reverse order from which they were received with the most recently received fax printed first, and so on.

4. Touch to select a fax and then touch **Print**.

Forward faxes to another number

You can set up the printer to forward your faxes to another fax number. All faxes are forwarded in black and white, regardless of how they were originally sent.

HP recommends that you verify the number you are forwarding to is a working fax line. Send a test fax to make sure the fax machine is able to receive your forwarded faxes.

To forward faxes from the printer control panel

1. From the printer control panel display, touch **Fax**.
2. Touch **Setup**.
3. Touch **Preferences**.
4. Touch **Fax Forwarding**.
5. Touch **On (Print and Forward)** to print and forward the fax or select **On (Forward)** to forward the fax.



NOTE: If the printer is not able to forward the fax to the designated fax machine (for example, if it is not turned on), the printer prints the fax. If you set up the printer to print error reports for received faxes, it also prints an error report.

6. At the prompt, enter the number of the fax machine intended to receive the forwarded faxes, and then touch **Done**. Enter the required information for each of the following prompts: start date, start time, end date, and end time.
7. Fax forwarding is activated. Touch **OK** to confirm.

If the printer loses power when fax forwarding is set up, it saves the fax forwarding setting and phone number. When the power is restored to the printer, the fax forwarding setting is still **On**.



NOTE: You can cancel fax forwarding by selecting **Off** from the **Fax Forwarding** menu.

Set automatic reduction for incoming faxes

The **Automatic Reduction** setting determines what the printer does if it receives a fax that is too large for the loaded paper size. This setting is turned on by default, so the image of the incoming fax is reduced to fit on one page, if possible. If this feature is turned off, information that does not fit on the first page is printed on a second page. **Automatic Reduction** is useful when you receive a fax larger than A4/Letter-size fax and A4/Letter-size paper is loaded in the input tray.

To set automatic reduction from the printer control panel

1. From the printer control panel display, touch **Fax**.
2. Touch **Setup**.
3. Touch **Preferences**.
4. Scroll to **Automatic Reduction** and touch to turn the feature on or off.

Block unwanted fax numbers

If you subscribe to a caller ID service through your phone provider, you can block specific fax numbers so the printer does not receive faxes received from those numbers. When an incoming fax call is received, the printer compares the number to the list of junk fax numbers to determine if the call should be blocked. If the number



matches a number in the blocked fax numbers list, the fax is not received. (The maximum number of fax numbers you can block varies by model.)

 **NOTE:** This feature is not supported in all countries/regions. If it is not supported in your country/region, **Junk Fax Blocking** does not appear in the **Preferences** menu.

 **NOTE:** If no phone numbers are added in the Caller ID list, it is assumed that you are not subscribed to a Caller ID service.

You can block specific fax numbers by adding them to the junk fax list, unblock these numbers by removing them from the junk fax list, and print a list of blocked junk fax numbers.

To add a number to the junk fax list

1. From the printer control panel display, touch **Fax**.
2. Touch **Setup**.
3. Touch **Preferences**.
4. Touch **Junk Fax Blocking**.
5. Touch **Plus Sign** .
6. Do one of the following:
 - To select a fax number to block from the call history list, touch **Call History** .
 - Manually enter a fax number to block and touch **Add**.

 **NOTE:** Make sure you enter the fax number as it appears on the control panel display and not the fax number that appears on the fax header of the received fax, as these numbers can be different.

To remove numbers from the junk fax list

1. From the printer control panel display, touch **Fax**.
2. Touch **Setup**.
3. Touch **Preferences**.
4. Touch **Junk Fax Blocking**.
5. Touch the number you want to remove and then touch **Remove**.

To print a junk fax list

1. From the printer control panel display, touch **Fax**.
2. Touch **Setup** and then touch **Reports**.
3. Touch **Print Fax Reports**.
4. Touch **Junk Fax Report**.
5. Touch **Print** to begin printing.

Receive faxes using HP Digital Fax

You can use HP Digital Fax to automatically receive faxes and save them directly to your computer. This saves paper and toner.

Received faxes are saved as TIFF (Tagged Image File Format) or PDF (Portable Document Format).

The files are named in the following method: XXXX_YYYYYYYY_ZZZZZZ.tif, where X is the sender's information, Y is the date, and Z is the time that the fax was received.



NOTE: Fax to Computer is available for receiving black-and-white faxes only.

HP Digital Fax requirements

- The destination folder of the computer must be available at all times. Faxes will not be saved if the computer is asleep or in hibernate mode.
- Paper must be loaded in the input tray. For more information, see [Load paper](#).

To set up or modify HP Digital Fax (Windows)

1. Open the HP printer software. For more information, see [Open the HP printer software \(Windows\)](#).
2. Click **Print, Scan & Fax**, and then click **Fax**.
3. Click **Digital Fax Setup Wizard**.
4. Follow the onscreen instructions.

To turn off HP Digital Fax

1. From the printer control panel display, touch **Fax**.
2. Touch **Setup**.
3. Touch **Preferences** and then touch **HP Digital Fax**.
4. Touch **Turn Off HP Digital Fax**.
5. Touch **Yes**.

Set up phone book contacts

You can set up frequently used fax numbers as phone book contacts. This lets you quickly dial those numbers using the printer control panel.



TIP: In addition to creating and managing phone book contacts from the printer control panel, you can also use tools available on your computer, such as the HP printer software and the printer EWS. For more information, see [Configure the printer using the Embedded Web Server \(EWS\)](#).

Create and edit a phone book contact

You can store fax numbers as phone book contacts.

To set up phone book contacts

1. From the printer control panel display, touch **Fax**.

2. Touch **Phone Book**.
3. Touch **Local Phone Book**.
4. Touch **Plus Sign**  to add a contact.
5. Touch **Name**, enter the name of the phone book contact, and then touch **Done**.
6. Touch **Fax Number**, enter the fax number for the phone book contact, and then touch **Done**.

 **NOTE:** Be sure to include any pauses or other required numbers, such as an area code, an access code for numbers outside a PBX system (usually a 9 or 0), or a long-distance prefix.

7. Touch **Add**.

To change phone book contacts

1. From the printer control panel display, touch **Fax**.
2. Touch **Phone Book**.
3. Touch **Local Phone Book**.
4. Touch the phone book contact that you want to edit.
5. Touch **Name**, edit the name of the Phone Book contact, and then touch **Done**.
6. Touch **Fax Number**, edit the fax number for the phone book contact, and then touch **Done**.

 **NOTE:** Be sure to include any pauses or other required numbers, such as an area code, an access code for numbers outside a PBX system (usually a 9 or 0), or a long-distance prefix.



7. Touch **Done**.

Create and edit a group phone book contact



You can store groups of fax numbers as group phone book contacts.

To set up group phone book contacts

 **NOTE:** Before you can create a group phone book contact, you must have already created at least one phone book contact.

1. From the printer control panel display, touch **Fax**.
2. Touch **Phone Book**, and then touch **Local Phone Book**.
3. Touch **Phone Book**  and select **Group**  to switch to the group phone book.
4. Touch **Plus Sign**  to add a group.
5. Touch **Name**, enter the name of the group, and then touch **Done**.
6. Touch **Number of Members**, select the phone book contacts you want to include in this group, and then touch **Select**.
7. Touch **Create**.

To change group phone book contacts

1. From the printer control panel display, touch **Fax**.
2. Touch **Phone Book** and then touch **Local Phone Book**.
3. Touch **Phone Book**  and select **Group**  to switch to the group phone book.
4. Touch the group phone book contact that you want to edit.
5. Touch **Name** and then edit the name of the group phone book contact, and then touch **Done**.
6. Touch **Number of Members**.
7. If you want to add a contact to the group, touch **Plus Sign** . Touch a contact name, and then touch **Select**.

 **NOTE:** If you want to remove a contact from the group, touch to deselect the contact.

8. Touch **Done**.



Delete phone book contacts

You can delete phone book contacts or group phone book contacts.

To delete phone book contacts

1. From the printer control panel display, touch **Fax**.
2. Touch **Phone Book**.
3. Touch **Local Phone Book**.
4. Touch the name of the phone book contact you want to delete.
5. Touch **Delete**.
6. Touch **Yes** to confirm.

To delete group phone book contacts

1. From the printer control panel display, touch **Fax**.
2. Touch **Phone Book** and then touch **Local Phone Book**.
3. Touch **Phone Book**  and select **Group**  to switch to the group phone book.
4. Touch the name of the group phone book contact you want to delete.
5. Touch **Delete**.
6. Touch **Yes** to confirm.

Change fax settings

After completing the steps in the Reference Guide that came with the printer, use the following steps to change the initial settings or to configure other options for faxing.

Configure the fax header

The fax header prints your name and fax number on the top of every fax you send. HP recommends that you set up the fax header by using the HP printer software. You can also set up the fax header from the printer control panel, as described here.



NOTE: In some countries/regions, the fax header information is a legal requirement.

To set or change the fax header

1. From the printer control panel display, touch **Fax**.
2. Touch **Setup**, and then touch **Preferences**.
3. Touch **Fax Header**.
4. Enter your personal or company name, and then touch **Done**.
5. Enter your fax number, and then touch **Done**.

Set the answer mode (Auto answer)

The answer mode determines whether the printer answers incoming calls.

- Turn on the **Auto Answer** setting if you want the printer to answer faxes **automatically**. The printer answers all incoming calls and faxes.
- Turn off the **Auto Answer** setting if you want to receive faxes **manually**. You must be available to respond in person to the incoming fax call or else the printer does not receive faxes.

To set the answer mode

1. From the printer control panel display, touch **Fax**.
2. Touch **Setup**, and then touch **Preferences**.
3. Touch **Auto Answer** to turn it on or off.



TIP: You may also access this feature by pressing the **Fax Status** button  on the Dashboard.

Set the number of rings before answering

If you turn on the **Auto Answer** setting, you can specify how many rings occur before incoming calls are automatically answered.

The **Rings to Answer** setting is important if you have an answering machine on the same phone line as the printer, because you want the answering machine to answer the phone before the printer does. The number of rings to answer for the printer should be greater than the number of rings to answer for the answering machine.

For example, set your answering machine to a low number of rings and the printer to answer in the maximum number of rings. (The maximum number of rings varies by country/region.) In this setup, the answering machine answers the call and the printer monitors the line. If the printer detects fax tones, it receives the fax. If the call is a voice call, the answering machine records the incoming message.

To set the number of rings before answering

1. From the printer control panel display, touch **Fax**.

2. Touch **Setup**, and then touch **Preferences**.
3. Touch **Rings to Answer**.
4. Touch to set the number of rings.
5. Touch **Done**.

Change the answer ring pattern for distinctive ring

Many phone companies offer a distinctive ring feature that allows you to have several phone numbers on one phone line. When you subscribe to this service, each number is assigned a different ring pattern. You can set up the printer to answer incoming calls that have a specific ring pattern.

If you connect the printer to a line with distinctive ring, have your telephone company assign one ring pattern to voice calls and another ring pattern to fax calls. HP recommends that you request double or triple rings for a fax number. When the printer detects the specified ring pattern, it answers the call and receives the fax.

 **TIP:** You can also use the Ring Pattern Detection feature in the printer control panel to set distinctive ring. With this feature, the printer recognizes and records the ring pattern of an incoming call and, based on this call, automatically determines the distinctive ring pattern assigned by your telephone company to fax calls.

If you do not have a distinctive ring service, use the default ring pattern, which is **All Standard Rings**.

 **NOTE:** The printer cannot receive faxes when the main phone number is off the hook.

To change the answer ring pattern for distinctive ring

1. Ensure that the printer is set to answer fax calls automatically.
For more information, see [To set the answer mode](#).
2. From the printer control panel display, touch **Fax**.
3. Touch **Setup**, and then select **Preferences**.
4. Touch **Distinctive Ring**.
5. Touch one ring pattern and then follow the onscreen instruction.

 **NOTE:** If you are using a PBX phone system that has different ring patterns for internal and external calls, you must call the fax number from an external number.

Set the dial type

Use this procedure to set tone-dialing or pulse-dialing mode. The factory-set default is **Tone**. Do not change the setting unless you know that your phone line cannot use tone dialing.

 **NOTE:** The pulse-dialing option is not available in all countries/regions.

To set the dial type

1. From the printer control panel display, touch **Fax**.
2. Touch **Setup**, and then touch **Preferences**.
3. Touch **Dial Type**.

4. Touch to select **Tone** or **Pulse**.

Set the redial options

If the printer was unable to send a fax because the receiving fax machine did not answer or was busy, the printer attempts to redial based on the settings for the redial options. Use the following procedure to turn the options on or off:

- **Busy Redial:** If this option is turned on, the printer redials automatically if it receives a busy signal. The default is **On**.
- **No Answer Redial:** If this option is turned on, the printer redials automatically if the receiving fax machine does not answer. The default is **Off**.
- **Connection Problem Redial:** If this option is turned on, the printer redials automatically if there has been a problem connecting with the receiving fax machine. Connection problem redial works only for sending faxes from memory. The default is **On**.

To set the redial options

1. From the printer control panel display, touch **Fax**.
2. Touch **Setup**, and then touch **Preferences**.
3. Touch **Auto Redial**.
4. Touch **Busy Redial**, **No Answer Redial**, or **Connection Problem Redial** to switch it on or off.

Set the fax speed

You can set the fax speed used to communicate between your printer and other fax machines when sending and receiving faxes.

If you use one of the following, setting the fax speed to a slower speed might be required:

- An Internet phone service
- A PBX (private branch exchange) system
- Fax on Voice over Internet Protocol (VoIP)
- An integrated services digital network (ISDN) service

If you experience problems sending and receiving faxes, try using a slower **Speed**. The following table provides the available fax speed settings.

Table 6-1 Set the fax speed

Fax speed setting	Fax speed
Fast	v.34 (33600 bps)
Medium	v.17 (14400 bps)
Slow	v.29 (9600 bps)

To set the fax speed

1. From the printer control panel display, touch **Fax**.

2. Touch **Setup**, and then touch **Preferences**.
3. Touch **Speed**.
4. Touch to select an option.

Set the fax sound volume

You can change the volume of fax sounds.

To set the fax sound volume

1. From the printer control panel display, touch **Fax**.
2. Touch **Setup** and then touch **Preferences**.
3. Touch **Fax Volume**.
4. Touch to select **Soft**, **Loud**, or **Off**.

 **TIP:** You may also access this feature by pressing the **Fax Status** button  on the Dashboard.

Fax and digital phone services

Many telephone companies provide their customers with digital phone services, such as the following:

- DSL: A digital subscriber line (DSL) service through your telephone company. (DSL might be called ADSL in your country/region.)
- PBX: A private branch exchange (PBX) phone system.
- ISDN: An integrated services digital network (ISDN) system.
- VoIP: A low-cost phone service that allows you to send and receive faxes with your printer by using the Internet. This method is called Fax on Voice over Internet Protocol (VoIP).

For more information, see [Fax on Voice over Internet Protocol](#).

HP printers are designed specifically for use with traditional analog phone services. If you are in a digital phone environment (such as DSL/ADSL, PBX, or ISDN), you might need to use digital-to-analog filters or converters when setting up the printer for faxing.

 **NOTE:** HP does not guarantee that the printer will be compatible with all digital service lines or providers, in all digital environments, or with all digital-to-analog converters. It is always recommended that you discuss with the telephone company directly for the correct setup options based on their line services provided.



Fax on Voice over Internet Protocol

You might be able to subscribe to a low-cost phone service that allows you to send and receive faxes with your printer by using the Internet. This method is called Fax on Voice over Internet Protocol (VoIP).

The following are indications you probably use a VoIP service:

- Dial a special access code along with the fax number.

- Have an IP converter box that connects to the Internet and provides analog phone ports for the fax connection.

 **NOTE:** You can only send and receive faxes by connecting a phone cord to the Fax port  on the back of the printer. This means that your connection to the Internet must be done either through a converter box (which supplies regular analog phone jacks for fax connections) or your telephone company.

 **TIP:** Support for traditional fax transmission over any Internet protocol telephone systems are often limited. If you experience problems faxing, try using a slower fax speed or disabling the fax error-correction mode (ECM).

If you have questions about Internet faxing, contact your Internet faxing services support department or your local service provider for further assistance.

Use reports

You can set up the printer to print error reports and confirmation reports automatically for each fax you send and receive. You can also manually print system reports as required; these reports provide useful system information about the printer.

By default, the printer is set to print a report only if there is a problem sending or receiving a fax. A confirmation message that indicates whether a fax was successfully sent appears briefly on the control panel display after each transaction.

 **NOTE:** If the reports are not legible, you can check the toner status from the control panel or the HP software.

 **NOTE:** Toner alerts and indicators provide estimates for planning purposes only. When you receive an alert on low toner, consider having a replacement cartridge available to avoid possible printing delays. You do not need to replace the cartridges until the print quality becomes unacceptable.

Print fax confirmation reports

You can print a confirmation report either when a fax is sent, or when any fax is sent or received. The default setting is **On (Fax Send)**. When turned off, a confirmation message appears briefly on the control panel after each fax is sent or received.

To enable fax confirmation

1. From the printer control panel display, touch **Fax**.
2. Touch **Setup**.
3. Touch **Reports** and touch **Fax Confirmation**.
4. Touch to select one of the following options.

Options	Confirmation report
On (Fax Send)	Prints a fax confirmation report for every fax you send.
On (Fax Receive)	Prints a fax confirmation report for every fax you receive.
On (Fax Send and Fax Receive)	Prints a fax confirmation report for every fax you send and receive.
Off	Does not print a fax confirmation report when you send and receive faxes successfully. This is the default setting.

To include an image of the fax on the report

1. From the printer control panel display, touch **Fax**.
2. Touch **Setup**.
3. Touch **Reports** and touch **Fax Confirmation**.
4. Touch **On (Fax Send)** or **On (Fax Send and Fax Receive)**.
5. Touch **Fax confirmation with image**.

Print fax error reports

You can configure the printer so that it automatically prints a report when there is an error during transmission or reception.

To set the printer to print fax error reports automatically

1. From the printer control panel display, touch **Fax**.
2. Touch **Setup**.
3. Touch **Reports** and touch **Fax Error Reports**.
4. Touch to select one of the following.

Fax error reports	Description
On (Fax Send)	Prints whenever a transmission error occurs. This is the default setting.
On (Fax Receive)	Prints whenever a receiving error occurs.
On (Fax Send and Fax Receive)	Prints whenever a fax error occurs.
Off	Does not print any fax error reports.

Print and view the fax log

You can print a log of faxes that have been received and sent by the printer.

To print the fax log from the printer control panel

1. From the printer control panel display, touch **Fax**.
2. Touch **Setup**, and then touch **Reports**.
3. Touch **Print Fax Reports**.
4. Touch **Last 500 Transactions Fax Logs**.
5. Touch **Print** to begin printing.

Clear the fax log

Clearing the fax log also deletes all faxes stored in memory.

To clear the fax log

1. From the printer control panel display, touch **Fax**.

2. Touch **Setup**, and then touch **Tools**.
3. Touch **Clear Fax Logs/Memory**.

Print the details of the last fax transaction

The Last Fax Transaction report prints the details of the last fax transaction to occur. Details include the fax number, number of pages, and the fax status.

To print the Last Fax Transaction report

1. From the printer control panel display, touch **Fax**.
2. Touch **Setup**, and then touch **Reports**.
3. Touch **Print Fax Reports**.
4. Touch **Last Transaction Log**.
5. Touch **Print** to begin printing.

Print a Caller ID Report

You can print a list of Caller ID fax numbers.

To print a Caller ID History Report

1. From the printer control panel display, touch **Fax**.
2. Touch **Setup**, and then touch **Reports**.
3. Touch **Print Fax Reports**.
4. Touch **Caller ID Report**.
5. Touch **Print** to begin printing.

View the Call History

You can view a list of all the calls placed from the printer.

 **NOTE:** You cannot print the call history.

To view the call history

1. From the printer control panel display, touch **Fax**.
2. Touch **Send Now**.
3. Touch **Phone Book** .
4. Touch **Call History**.

Additional fax setup

After completing all the steps in the Getting Started Guide, use the instructions in this section to complete your fax setup. Keep your Getting Started Guide for later use.

In this section, you learn how to set up the printer so that faxing works successfully with equipment and services you might already have on the same phone line.

 **TIP:** You can also use the Fax Setup Wizard (Windows) to help you quickly set up some important fax settings such as the answer mode and fax header information. You can access these tools through the HP printer software. After you run these tools, follow the procedures in this section to complete your fax setup.

Set up faxing (parallel phone systems)

Before you begin setting up the printer for faxing, determine which kind of phone system your country/region uses. The instructions for fax setup differ depending on whether you have a serial- or parallel-type phone system:

- If you do not see your country/region listed in the table, you probably have a serial-type phone system. In a serial-type phone system, the connector type on your shared telephone equipment (modems, phones, and answering machines) does not allow a physical connection to the Fax port  on the back of the printer. Instead, all equipment must be connected at the telephone wall jack.

 **NOTE:** You might need to connect the phone cord to your country/region adapter.

- If your country/region is listed in the table, you probably have a parallel-type telephone system. In a parallel-type phone system, you are able to connect shared telephone equipment to the phone line by using the Fax port  on the back of the printer.

 **NOTE:** If you have a parallel-type phone system, HP recommends you connect a 2-wire phone cord to the telephone wall jack.

Table 6-2 Countries/regions with a parallel-type phone system

Countries/regions	Countries/regions	Countries/regions	Countries/regions
Argentina	Australia	Brazil	Canada
Chile	China	Colombia	Greece
India	Indonesia	Ireland	Japan
Korea	Latin America	Malaysia	Mexico
Philippines	Poland	Portugal	Russia
Saudi Arabia	Singapore	Spain	Taiwan region
Thailand	USA	Venezuela	Vietnam

If you are unsure which kind of telephone system you have (serial or parallel), check with your telephone company.



Select the correct fax setup for your home or office

To fax successfully, you need to know what types of equipment and services (if any) share the same phone line with the printer. This is important because you might need to connect some of your existing office equipment directly to the printer, and you might also need to change some fax settings before you can fax successfully.

1. Determine if your telephone system is serial or parallel.

For more information, see [Set up faxing \(parallel phone systems\)](#).

- a. Serial-type telephone system.
 - b. Parallel-type telephone system—Go to step 2.
2. Select the combination of equipment and services sharing your fax line.
- DSL: A digital subscriber line (DSL) service through your telephone company. (DSL might be called ADSL in your country/region.)
 - PBX: A private branch exchange (PBX) phone system.
 - ISDN: An integrated services digital network (ISDN) system.
 - Distinctive ring service: A distinctive ring service through your telephone company provides multiple telephone numbers with different ring patterns.
 - Voice calls: Voice calls are received at the same phone number you use for fax calls on the printer.
 - Computer dial-up modem: A computer dial-up modem is on the same phone line as the printer. If you answer Yes to any of the following questions, you are using a computer dial-up modem:
 - Do you send and receive faxes directly to and from your computer software applications through a dial-up connection?
 - Do you send and receive email messages on your computer through a dial-up connection?
 - Do you access the Internet from your computer through a dial-up connection?
 - Answering machine: An answering machine that answers voice calls at the same phone number you use for fax calls on the printer.
 - Voice mail service: A voice mail subscription through your telephone company at the same number you use for fax calls on the printer.
3. From the following table, select the combination of equipment and services applicable to your home or office setting. Then look up the recommended fax setup. Step-by-step instructions are included for each case in the sections that follow.

 **NOTE:** If your home or office setup is not described in this section, set up the printer as you would a regular analog phone. Connect one end of the phone cord to your telephone wall and the other end to the Fax port  on the back of the printer.

You might need to connect the phone cord to your country/region adapter.

Table 6-3 Combination of equipment and services sharing your fax line

Recommended fax setup	Combinations sharing your fax line
To set up the printer with a separate fax line	Fax line
To set up the printer with DSL	DSL
Case C: Set up the printer with a PBX phone system or an ISDN line	PBX
To set up the printer with a distinctive ring service	Distinctive ring service
To set up the printer with a shared voice/fax line	Voice calls
To set up the printer with voice mail	Voice calls and/or voice mail service
Case G: Fax line shared with computer modem (no voice calls received)	Computer dial-up modem

Table 6-3 Combination of equipment and services sharing your fax line (continued)

Recommended fax setup	Combinations sharing your fax line
Case H: Shared voice/fax line with computer modem	Voice calls and/or computer dial-up modem
To set up the printer with a shared voice/fax line with answering machine	Voice calls and/or answering machine
Case J: Shared voice/fax line with computer modem and answering machine	Voice calls, computer dial-up modem, and/or answering machine
To set up the printer on the same phone line as a computer with two phone ports	Voice calls, computer dial-up modem, and/or voice mail service

Case A: Separate fax line (no voice calls received)

If you have a separate phone line on which you receive no voice calls, and you have no other equipment connected on this phone line, set up the printer as described in this section.

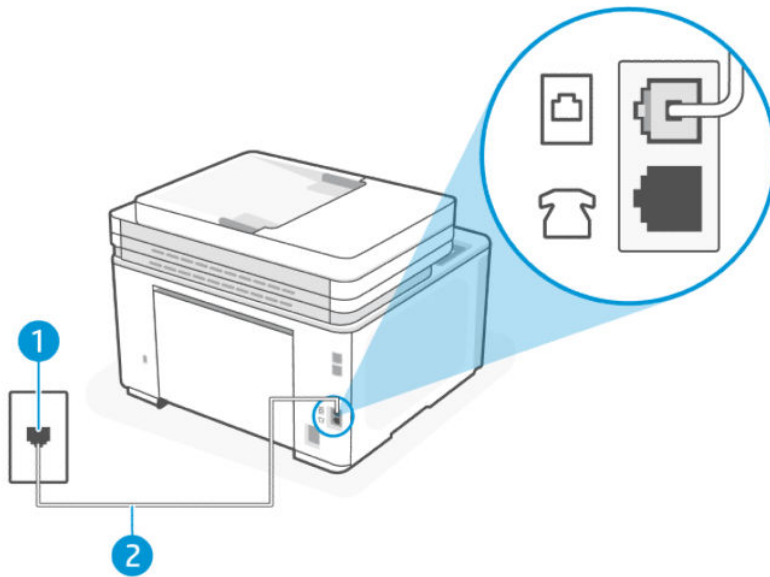





Table 6-4 Back view of the printer

Feature	Description
1	Telephone wall jack.
2	Use a minimum 26 AWG phone cord to connect to the Fax port  on the printer. You might need to connect the phone cord to your country/region adapter.

To set up the printer with a separate fax line

1. Connect one end of the phone cord to your telephone wall jack, then connect the other end to the Fax port  on the back of the printer.

 **NOTE:** You might need to connect the phone cord to your country/region adapter.

2. Touch **Fax, Setup, and Preferences**.
3. Turn on the **Auto Answer** setting.
4. (Optional) Change the **Rings to Answer** setting to the lowest setting (two rings).
5. Run a fax test.

When the phone rings, the printer answers automatically after the number of rings you set in the **Rings to Answer** setting. The printer begins emitting fax reception tones to the sending fax machine and receives the fax.

Case B: Set up the printer with DSL

If you have a DSL service through your telephone company, and do not connect any equipment to the printer, use the instructions in this section to connect a DSL filter between the telephone wall jack and the printer. The DSL filter removes the digital signal that can interfere with the printer, so the printer can communicate correctly with the phone line. (DSL might be called ADSL in your country/region.)

 **NOTE:** If you have a DSL line and you do not connect the DSL filter, you cannot send and receive faxes with the printer.

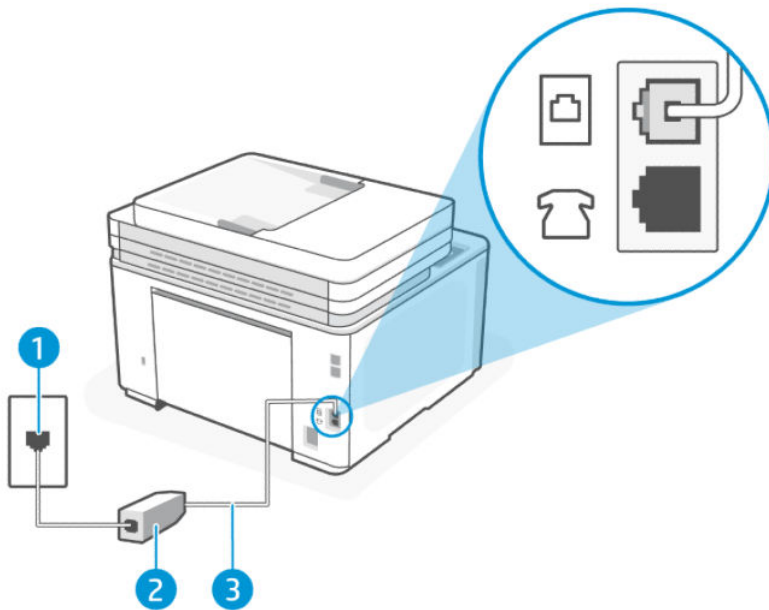



Table 6-5 Back view of the printer

Feature	Description
1	Telephone wall jack.
2	DSL (or ADSL) filter and cord supplied by your DSL provider.

Table 6-5 Back view of the printer (continued)

Feature	Description
3	Use a minimum 26 AWG phone cord to connect to the Fax port  on the printer. You might need to connect the phone cord to your country/region adapter.

To set up the printer with DSL

1. Obtain a DSL filter from your DSL provider.
2. Connect one end of the phone cord to the DSL filter, and then connect the other end to the Fax port  on the back of the printer.



NOTE: You might need to connect the phone cord to your country/region adapter.

Get additional phone cords for this setup if needed. You can purchase phone cords from electronics stores that sell phone accessories.

3. Connect an additional phone cord from the DSL filter to the telephone wall jack.
4. Run a fax test.

If you encounter problems setting up the printer with optional equipment, contact your local service provider or vendor for further assistance.

Case C: Set up the printer with a PBX phone system or an ISDN line

If you are using either a PBX phone system or an ISDN converter/terminal adaptor, make sure you do the following:

- If you are using either a PBX or an ISDN converter/terminal adaptor, connect the printer to the port that is designated for fax and phone use. Also, make sure that the terminal adaptor is set to the correct switch type for your country/region, if possible.



NOTE: Some ISDN systems allow you to configure the ports for specific phone equipment. For example, you might have assigned one port for telephone and Group 3 fax and another port for multiple purposes. If you have problems when connected to the fax/phone port of your ISDN converter, try using the port designated for multiple purposes; it might be labeled "multi-combi" or something similar.

- If you are using a PBX phone system, set the call waiting tone to "off."



NOTE: Many digital PBX systems include a call-waiting tone that is set to "on" by default. The call waiting tone interferes with any fax transmission, and you cannot send or receive faxes with the printer. Refer to the documentation that came with your PBX phone system for instructions on how to turn off the call-waiting tone.

- If you are using a PBX phone system, dial the number for an outside line before dialing the fax number.
- You might need to connect the phone cord to your country/region adapter.

If you encounter problems setting up the printer with optional equipment, contact your local service provider or vendor for further assistance.

Case D: Fax with a distinctive ring service on the same line

If you subscribe to a distinctive ring service (through your telephone company) that allows you to have multiple phone numbers on one phone line, each with a different ring pattern, set up the printer as described in this section.

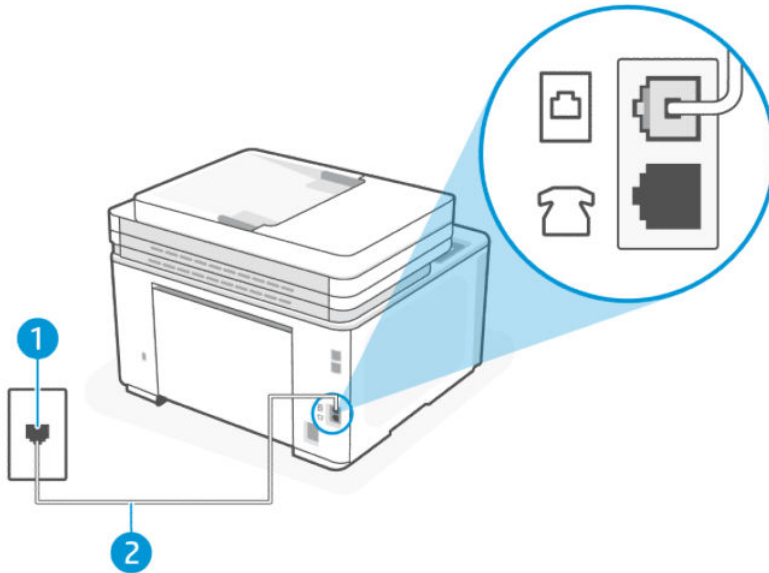



Table 6-6 Back view of the printer

Feature	Description
1	Telephone wall jack.
2	Use a minimum 26 AWG phone cord to connect to the Fax port  on the printer. You might need to connect the phone cord to your country/region adapter.

To set up the printer with a distinctive ring service

1. Connect one end of the phone cord to your telephone wall jack, then connect the other end to the Fax port  on the back of the printer.

 **NOTE:** You might need to connect the phone cord to your country/region adapter.

2. Touch **Fax, Setup, and Preferences.**
3. Turn on the **Auto Answer** setting.

4. Change the **Distinctive Ring** setting to match the pattern that the telephone company assigned to your fax number.

 **NOTE:** By default, the printer is set to answer all ring patterns. If you do not set the **Distinctive Ring** to match the ring pattern assigned to your fax number, the printer might answer both voice calls and fax calls or it might not answer at all.

 **TIP:** You can also use the Ring Pattern Detection feature in the printer control panel to set distinctive ring. With this feature, the printer recognizes and records the ring pattern of an incoming call and, based on this call, automatically determines the distinctive ring pattern assigned by your telephone company to fax calls. For more information, see [To change the answer ring pattern for distinctive ring](#).

5. (Optional) Change the **Rings to Answer** setting to the lowest setting (two rings).
6. Run a fax test.

The printer automatically answers incoming calls that have the ring pattern you selected (**Distinctive Ring** setting) after the number of rings you selected (**Rings to Answer** setting). The printer begins emitting fax reception tones to the sending fax machine and receives the fax.

If you encounter problems setting up the printer with optional equipment, contact your local service provider or vendor for further assistance.

Case E: Shared voice/fax line

If you receive both voice calls and fax calls at the same phone number, and you have no other office equipment (or voice mail) on this phone line, set up the printer as described in this section.

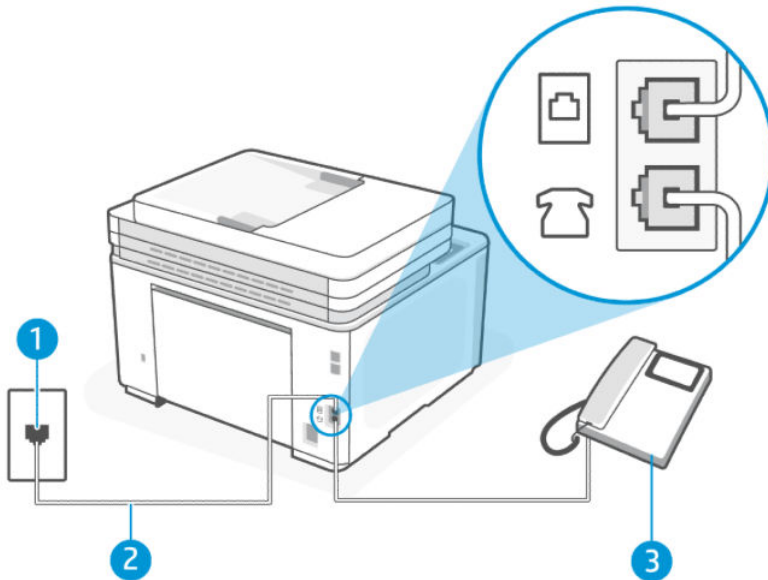



Table 6-7 Back view of the printer

Feature	Description
1	Telephone wall jack.

Table 6-7 Back view of the printer (continued)

Feature	Description
2	Use a minimum 26 AWG phone cord to connect to the Fax port  on the printer. You might need to connect the phone cord to your country/region adapter.
3	Telephone (optional).

To set up the printer with a shared voice/fax line

1. Connect one end of the phone cord to your telephone wall jack, then connect the other end to the Fax port  on the back of the printer.

 **NOTE:** You might need to connect the phone cord to your country/region adapter.

2. Do one of the following:
 - If you have a parallel-type phone system, connect a phone to the Fax port  on the back of the printer.
 - If you have a serial-type phone system, you might plug your phone directly on top of the printer cable which has a wall plug attached to it.
3. Now you need to decide how you want the printer to answer calls, automatically or manually:
 - If you set up the printer to answer calls **automatically**, it answers all incoming calls and receives faxes. The printer cannot distinguish between fax and voice calls in this case; if you suspect the call is a voice call, you need to answer it before the printer answers the call. To set up the printer to answer calls automatically, turn on the **Auto Answer** setting.
 - If you set up the printer to answer faxes **manually**, you must be available to respond in person to incoming fax calls or the printer cannot receive faxes. To set up the printer to answer calls manually, turn off the **Auto Answer** setting.
4. Run a fax test.

If you pick up the phone before the printer answers the call and hear fax tones from a sending fax machine, you need to answer the fax call manually.

If you encounter problems setting up the printer with optional equipment, contact your local service provider or vendor for further assistance.

Case F: Shared voice/fax line with voice mail

If you receive both voice calls and fax calls at the same phone number, and you also subscribe to a voice mail service through your telephone company, set up the printer as described in this section.

 **NOTE:** You cannot receive faxes automatically if you have a voice mail service at the same phone number you use for fax calls. You must receive faxes manually; this means you must be available to respond in person to incoming fax calls. If you want to receive faxes automatically instead, contact your telephone company to subscribe to a distinctive ring service, or to obtain a separate phone line for faxing.

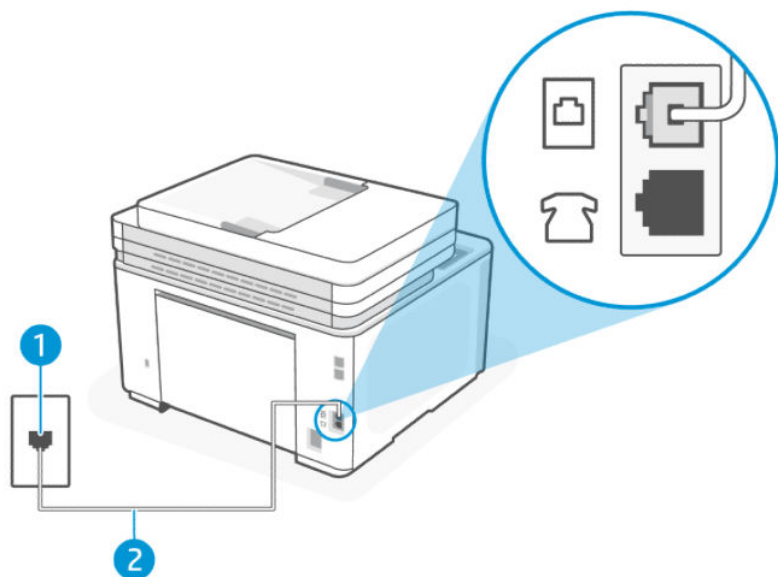





Table 6-8 Back view of the printer

Feature	Description
1	Telephone wall jack.
2	Use a minimum 26 AWG phone cord to connect to the Fax port  on the printer. You might need to connect the phone cord to your country/region adapter.

To set up the printer with voice mail

1. Connect one end of the phone cord to your telephone wall jack, then connect the other end to the Fax port  on the back of the printer.

 **NOTE:** You might need to connect the phone cord to your country/region adapter.

2. Touch **Fax, Setup,** and **Preferences.**
3. Turn off the **Auto Answer** setting.
4. Run a fax test.

You must be available to respond in person to incoming fax calls, or the printer cannot receive faxes. You must initiate the manual fax before voicemail picks up the line.

If you encounter problems setting up the printer with optional equipment, contact your local service provider or vendor for further assistance.

Case G: Fax line shared with computer modem (no voice calls received)

If you have a fax line on which you receive no voice calls, and you also have a computer modem connected on this line, set up the printer as described in this section.

 **NOTE:** If you have a computer dial-up modem, your computer dial-up modem shares the phone line with the printer. You cannot use both your modem and the printer simultaneously. For example, you cannot use the printer for faxing while you are using your computer dial-up modem to send an email or access the Internet.

Set up the printer with a computer dial-up modem

If you are using the same phone line for sending faxes and for a computer dial-up modem, follow these directions for setting up the printer.

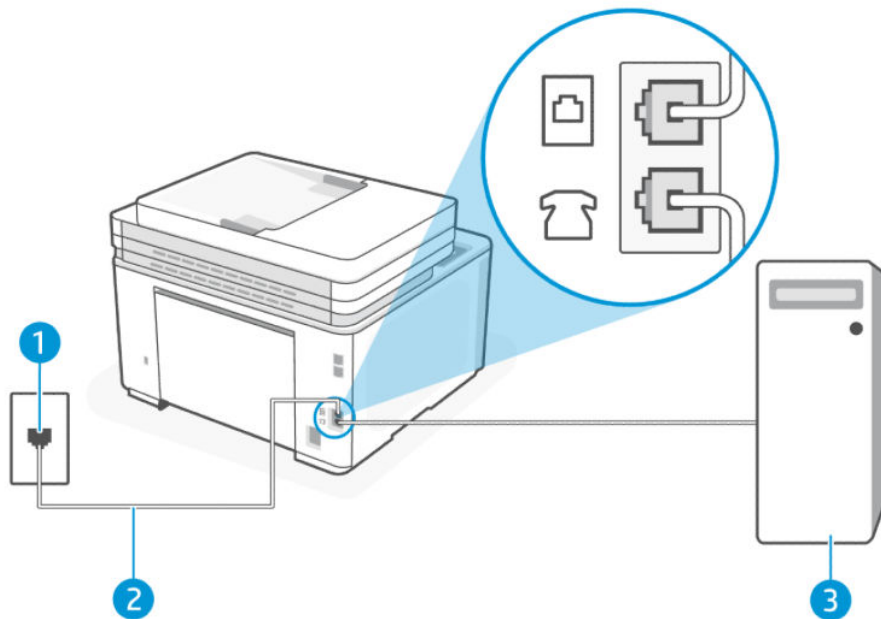





Table 6-9 Back view of the printer

Feature	Description
1	Telephone wall jack.
2	Use a minimum 26 AWG phone cord to connect to the Fax port  on the printer. You might need to connect the phone cord to your country/region adapter.
3	Computer with modem.

To set up the printer with a computer dial-up modem

1. Find the phone cord that connects from the back of your computer (your computer dial-up modem) to a telephone wall jack. Disconnect the cord from the telephone wall jack and plug it into the Fax port  on the back of the printer.

2. Connect one end of the phone cord to your telephone wall jack, then connect the other end to the Fax port  on the back of the printer.

 **NOTE:** You might need to connect the phone cord to your country/region adapter.

3. If your modem software is set to receive faxes to your computer automatically, turn off that setting.

 **NOTE:** If you do not turn off the automatic fax reception setting in your modem software, the printer cannot receive faxes.

4. Touch **Fax, Setup, and Preferences**.
5. Turn on the **Auto Answer** setting.
6. (Optional) Change the **Rings to Answer** setting to the lowest setting (two rings).
7. Run a fax test.

When the phone rings, the printer automatically answers after the number of rings you set in the **Rings to Answer** setting. The printer begins emitting fax reception tones to the sending fax machine and receives the fax.

If you encounter problems setting up the printer with optional equipment, contact your local service provider or vendor for further assistance.

Set up the printer with a computer DSL/ADSL modem

If you have a DSL line and use that phone line to send faxes, follow these instructions to set up your fax.

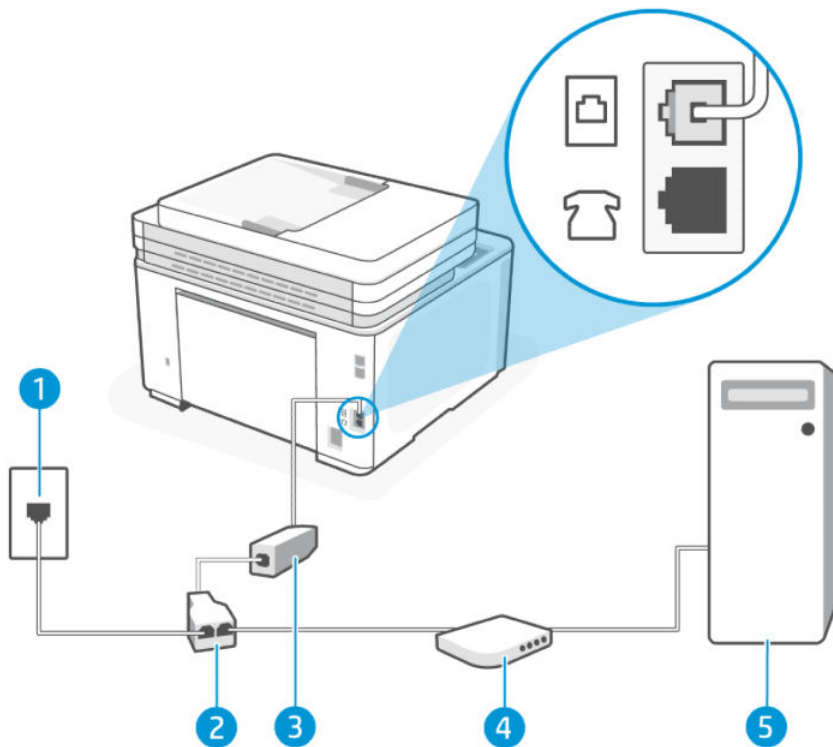



Table 6-10 Back view of the printer

Feature	Description
1	Telephone wall jack.
2	Parallel splitter.
3	DSL/ADSL filter. Connect one end of the phone cord to the Fax port  on the back of the printer. Connect the other end of the cord to the DSL/ADSL filter. You might need to connect the phone cord to your country/region adapter.
4	Computer.
5	Computer DSL/ADSL modem.



 **NOTE:** You need to purchase a parallel splitter. A parallel splitter has one RJ-11 port on the front and two RJ-11 ports on the back. Do not use a 2-line phone splitter, a serial splitter, or a parallel splitter which has two RJ-11 ports on the front and a plug on the back.

Figure 6-1 Example of a parallel splitter



To set up the printer with a computer DSL/ADSL modem

1. Obtain a DSL filter from your DSL provider.
2. Connect one end of the phone cord to the DSL filter, and then connect the other end to the Fax port  on the back of the printer.

 **NOTE:** You might need to connect the phone cord to your country/region adapter.

3. Connect the DSL filter to the parallel splitter.
4. Connect the DSL modem to the parallel splitter.
5. Connect the parallel splitter to the wall jack.
6. Run a fax test.

When the phone rings, the printer automatically answers after the number of rings you set in the **Rings to Answer** setting. The printer begins emitting fax reception tones to the sending fax machine and receives the fax.

If you encounter problems setting up the printer with optional equipment, contact your local service provider or vendor for further assistance.

Case H: Shared voice/fax line with computer modem

There are two different ways to set up the printer with your computer based on the number of phone ports on your computer. Before you begin, check your computer to see if it has one or two phone ports.

Shared voice/fax with computer dial-up modem

If you use your phone line for both fax and telephone calls, use these instructions to set up your fax.

There are two different ways to set up the printer with your computer based on the number of phone ports on your computer. Before you begin, check your computer to see if it has one or two phone ports.

NOTE: If your computer has only one phone port, you need to purchase a parallel splitter (also called a coupler), as shown in the illustration. (A parallel splitter has one RJ-11 port on the front and two RJ-11 ports on the back. Do not use a two-line phone splitter, a serial splitter, or a parallel splitter which has two RJ-11 ports on the front and a plug on the back.)

Figure 6-2 Example of a parallel splitter

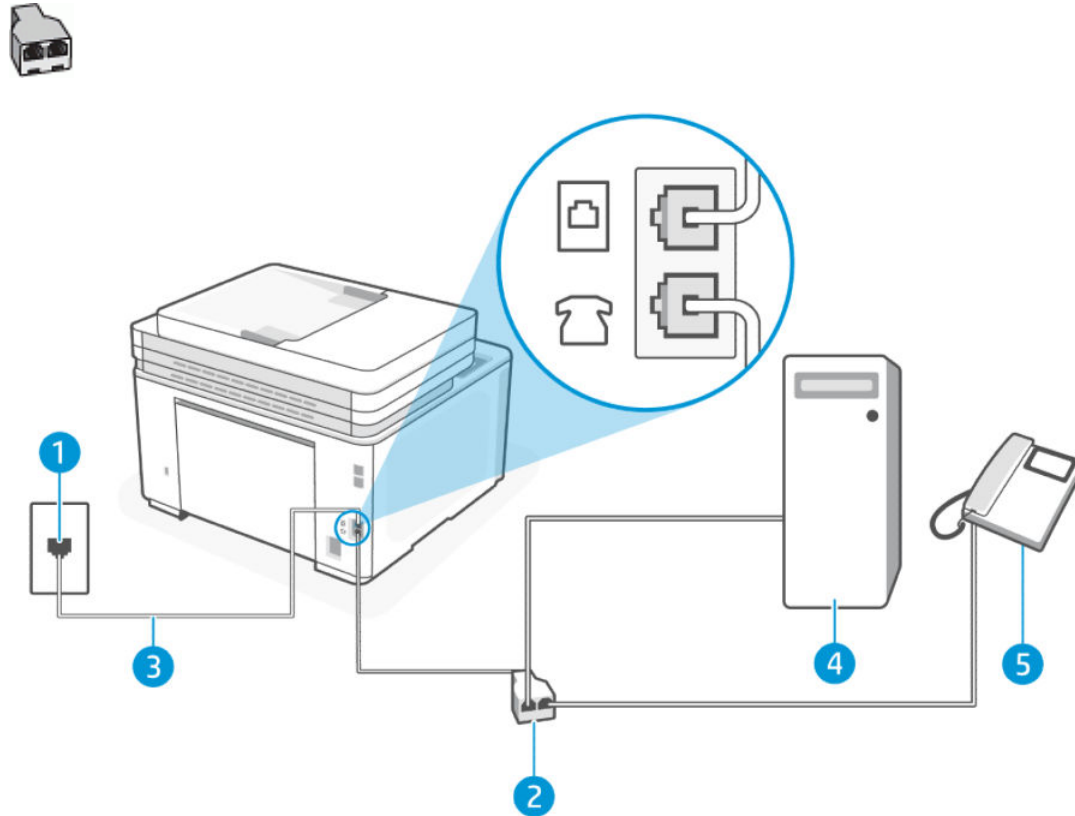





Table 6-11 Back view of the printer

Feature	Description
1	Telephone wall jack.
2	Parallel splitter.
3	Use a minimum 26 AWG phone cord to connect to the Fax port  on the printer.
4	Computer with modem.
5	Telephone.

To set up the printer on the same phone line as a computer with two phone ports

1. Find the phone cord that connects from the back of your computer (your computer dial-up modem) to a telephone wall jack. Disconnect the cord from the telephone wall jack and plug it into the Fax port  on the back of the printer.

2. Connect a phone to the "OUT" port on the back of your computer dial-up modem.
3. Connect one end of the phone cord to your telephone wall jack, then connect the other end to the Fax port  on the back of the printer.



NOTE: You might need to connect the phone cord to your country/region adapter.

4. If your modem software is set to receive faxes to your computer automatically, turn off that setting.



NOTE: If you do not turn off the automatic fax reception setting in your modem software, the printer cannot receive faxes.

5. Now you need to decide how you want the printer to answer calls, automatically or manually:
 - If you set up the printer to answer calls **automatically**, it answers all incoming calls and receives faxes. The printer cannot distinguish between fax and voice calls in this case; if you suspect the call is a voice call, you need to answer it before the printer answers the call. To set up the printer to answer calls automatically, turn on the **Auto Answer** setting.
 - If you set up the printer to answer faxes **manually**, you must be available to respond in person to incoming fax calls or the printer cannot receive faxes. To set up the printer to answer calls manually, turn off the **Auto Answer** setting.
6. Run a fax test.

If you pick up the phone before the printer answers the call and hear fax tones from a sending fax machine, you need to answer the fax call manually.

If you use your phone line for voice, fax, and your computer dial-up modem, follow these directions to set up your fax.

If you encounter problems setting up the printer with optional equipment, contact your local service provider or vendor for further assistance.

Shared voice/fax with computer DSL/ADSL modem

Use these instructions if your computer has a DSL/ADSL modem

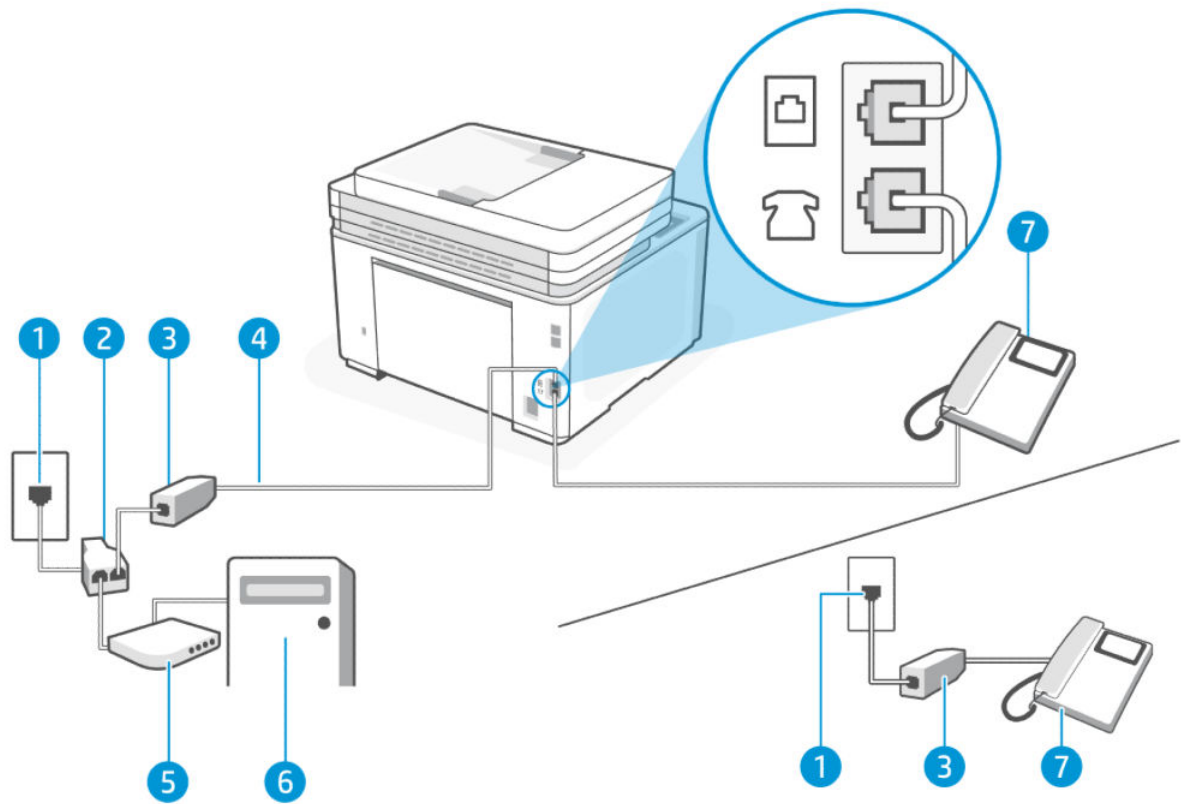



Table 6-12 Back view of the printer

Feature	Description
1	Telephone wall jack.
2	Parallel splitter.
3	DSL/ADSL filter.
4	Use a minimum 26 AWG phone cord to connect to the Fax port  on the printer. You might need to connect the phone cord to your country/region adapter.
5	DSL/ADSL modem.
6	Computer.
7	Telephone.



 **NOTE:** You need to purchase a parallel splitter. A parallel splitter has one RJ-11 port on the front and two RJ-11 ports on the back. Do not use a 2-line phone splitter, a serial splitter, or a parallel splitter which has two RJ-11 ports on the front and a plug on the back.

Figure 6-3 Example of a parallel splitter





To set up the printer with a computer DSL/ADSL modem

1. Obtain a DSL filter from your DSL provider.

 **NOTE:** Phones in other parts of the home/office sharing the same phone number with DSL service need to be connected to additional DSL filters to avoid noise when making voice calls.

2. Connect one end of the phone cord to the DSL filter, and then connect the other end to the Fax port  on the back of the printer.

 **NOTE:** You might need to connect the phone cord to your country/region adapter.

3. If you have a parallel-type phone system, connect a phone to the Fax port  on the back of the printer.
4. Connect the DSL filter to the parallel splitter.
5. Connect the DSL modem to the parallel splitter.
6. Connect the parallel splitter to the wall jack.
7. Run a fax test.

When the phone rings, the printer automatically answers after the number of rings you set in the **Rings to Answer** setting. The printer begins emitting fax reception tones to the sending fax machine and receives the fax.

If you encounter problems setting up the printer with optional equipment, contact your local service provider or vendor for further assistance.

Case I: Shared voice/fax line with answering machine

This topic describes the shared voice/fax line with answering machine.

If you receive both voice calls and fax calls at the same phone number, and you also have an answering machine that answers voice calls at this phone number, set up the printer as described in this section.

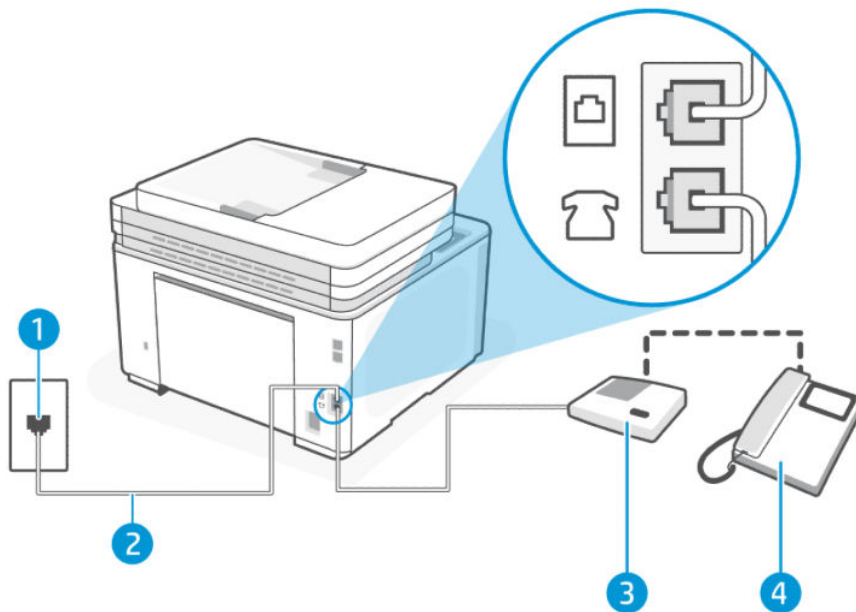





Table 6-13 Back view of the printer

Feature	Description
1	Telephone wall jack.
2	Use a minimum 26 AWG phone cord to connect to the Fax port  on the printer. You might need to connect the phone cord to your country/region adapter.
3	Answering machine.
4	Telephone (optional).

To set up the printer with a shared voice/fax line with answering machine

1. Unplug your answering machine from the telephone wall jack and connect it to the Fax port  on the back of the printer.

 **NOTE:** If you do not connect your answering machine directly to the printer, fax tones from a sending fax machine might be recorded on your answering machine, and you might not receive faxes with the printer.

2. Connect one end of the phone cord to your telephone wall jack, then connect the other end to the Fax port  on the back of the printer.

 **NOTE:** You might need to connect the phone cord to your country/region adapter.

3. (Optional) If your answering machine does not have a built-in phone, for convenience you might want to connect a phone to the back of your answering machine at the "OUT" port.

 **NOTE:** If your answering machine does not let you connect an external phone, you can purchase and use a parallel splitter (also known as a coupler) to connect both the answering machine and telephone to the printer. You can use standard phone cords for these connections.

4. Touch **Fax, Setup, and Preferences**.
5. Turn on the **Auto Answer** setting.
6. Set your answering machine to answer after a low number of rings.
7. Change the **Rings to Answer** setting on the printer to the maximum number of rings supported by your printer. (The maximum number of rings varies by country/region.)
8. Run a fax test.

When the phone rings, your answering machine answers after the number of rings you have set, and then plays your recorded greeting. The printer monitors the call during this time, "listening" for fax tones. If incoming fax tones are detected, the printer emits fax reception tones and receives the fax; if there are no fax tones, the printer stops monitoring the line and your answering machine can record a voice message.

If you encounter problems setting up the printer with optional equipment, contact your local service provider or vendor for further assistance.

Case J: Shared voice/fax line with computer modem and answering machine

If you receive both voice calls and fax calls at the same phone number, and you also have a computer modem and answering machine connected on this phone line, set up the printer as described in this section.

NOTE: Since your computer dial-up modem shares the phone line with the printer, you cannot use both your modem and the printer simultaneously. For example, you cannot use the printer for faxing while you are using your computer dial-up modem to send an email or access the Internet.

Shared voice/fax line with computer dial-up modem and answering machine

There are two different ways to set up the printer with your computer based on the number of phone ports on your computer. Before you begin, check your computer to see if it has one or two phone ports.

NOTE: If your computer has only one phone port, you need to purchase a parallel splitter (also called a coupler), as shown in the illustration. (A parallel splitter has one RJ-11 port on the front and two RJ-11 ports on the back. Do not use a two-line phone splitter, a serial splitter, or a parallel splitter which has two RJ-11 ports on the front and a plug on the back.)

Figure 6-4 Example of a parallel splitter

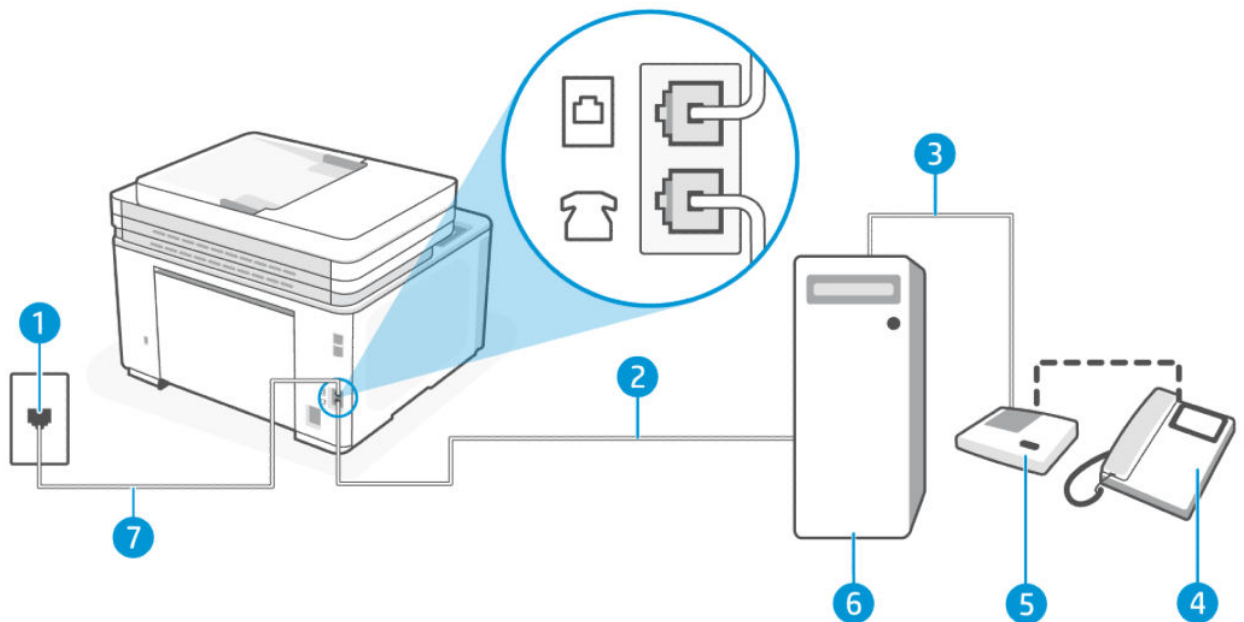





Table 6-14 Back view of the printer

Feature	Description
1	Telephone wall jack.
2	"IN" phone port on your computer.
3	"OUT" phone port on your computer.

Table 6-14 Back view of the printer (continued)

Feature	Description
4	Telephone (optional).
5	Answering machine.
6	Computer with modem.
7	Use a minimum 26 AWG phone cord to connect to the Fax port  on the printer. You might need to connect the phone cord to your country/region adapter.

To set up the printer on the same phone line as a computer with two phone ports

1. Find the phone cord that connects from the back of your computer (your computer dial-up modem) to a telephone wall jack. Disconnect the cord from the telephone wall jack and plug it into the Fax port  on the back of the printer.
2. Unplug your answering machine from the telephone wall jack and connect it to the port labeled "OUT" on the back of the computer (the computer dial-up modem).
3. Connect one end of the phone cord to your telephone wall jack, then connect the other end to the Fax port  on the back of the printer.

 **NOTE:** You might need to connect the phone cord to your country/region adapter.

4. (Optional) If your answering machine does not have a built-in phone, for convenience you might want to connect a phone to the back of your answering machine at the "OUT" port.

 **NOTE:** If your answering machine does not let you connect an external phone, you can purchase and use a parallel splitter (also known as a coupler) to connect both the answering machine and telephone to the printer. You can use standard phone cords for these connections.

5. If your modem software is set to receive faxes to your computer automatically, turn off that setting.

 **NOTE:** If you do not turn off the automatic fax reception setting in your modem software, the printer cannot receive faxes.

6. Touch **Fax, Setup, and Preferences**.
7. Turn on the **Auto Answer** setting.
8. Set your answering machine to answer after a low number of rings.
9. Change the **Rings to Answer** setting on the printer to the maximum number of rings supported by the product. (The maximum number of rings varies by country/region.)
10. Run a fax test.

When the phone rings, your answering machine answers after the number of rings you have set, and then plays your recorded greeting. The printer monitors the call during this time, "listening" for fax tones. If incoming fax tones are detected, the printer emits fax reception tones and receives the fax; if there are no fax tones, the printer stops monitoring the line and your answering machine can record a voice message.

If you encounter problems setting up the printer with optional equipment, contact your local service provider or vendor for further assistance.

Shared voice/fax line with computer DSL/ADSL modem and answering machine

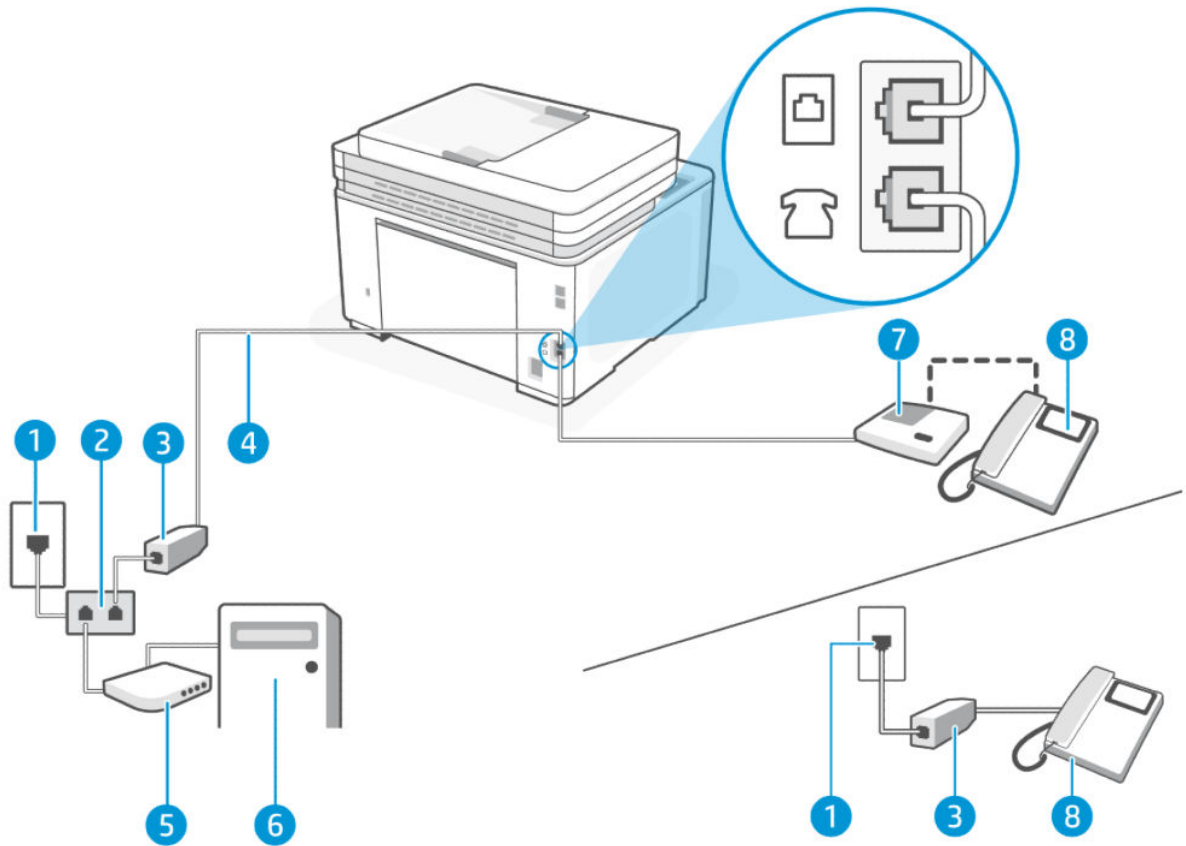



Table 6-15 Back view of the printer

Feature	Description
1	Telephone wall jack.
2	Parallel splitter.
3	DSL/ADSL filter.
4	Use a minimum 26 AWG phone cord to connect to the Fax port  on the printer. You might need to connect the phone cord to your country/region adapter.
5	DSL/ADSL modem.
6	Computer.
7	Answering machine.
8	Telephone (optional).



 **NOTE:** You need to purchase a parallel splitter. A parallel splitter has one RJ-11 port on the front and two RJ-11 ports on the back. Do not use a 2-line phone splitter, a serial splitter, or a parallel splitter which has two RJ-11 ports on the front and a plug on the back.

Figure 6-5 Example of a parallel splitter



To set up the printer with a computer DSL/ADSL modem

1. Obtain a DSL/ADSL filter from your DSL/ADSL provider.

 **NOTE:** Phones in other parts of the home/office sharing the same phone number with DSL/ADSL service need to be connected to additional DSL/ADSL filters, to avoid noise when making voice calls.

2. Connect one end of the phone cord to the DSL/ADSL filter and then connect the other end to the Fax port  on the back of the printer.

 **NOTE:** You might need to connect the phone cord to your country/region adapter.

3. Connect the DSL/ADSL filter to the splitter.
4. Unplug the answering machine from the telephone wall jack, and connect it to the Fax port  on the back of the printer.

 **NOTE:** If you do not connect your answering machine directly to the printer, fax tones from a sending fax machine might be recorded on your answering machine, and you might not receive faxes with the printer.

5. Connect the DSL modem to the parallel splitter.
6. Connect the parallel splitter to the wall jack.
7. Set your answering machine to answer after a low number of rings.
8. Change your **Rings to Answer** setting on the printer to the maximum number of rings supported by the printer.

 **NOTE:** The maximum number of rings varies by country/region.

9. Run a fax test.

When the phone rings, your answering machine answers after the number of rings you have set, and then play your recorded greeting. The printer monitors the call during this time, “listening” for fax tones. If incoming fax tones are detected, the printer emits fax reception tones and receive the fax; if there are no fax tones, the printer stops monitoring the line and your answering machine can record a voice message.

If you use the same phone line for telephone, fax, and have a computer DSL modem, follow these instructions to set up your fax.

If you encounter problems setting up the printer with optional equipment, contact your local service provider or vendor for further assistance.

Case K: Shared voice/fax line with computer dial-up modem and voice mail

If you receive both voice calls and fax calls at the same phone number, use a computer dial-up modem on the same phone line, and subscribe to a voice mail service through your telephone company, set up the printer as described in this section.

 **NOTE:** You cannot receive faxes automatically if you have a voice mail service at the same phone number you use for fax calls. You must receive faxes manually; this means you must be available to respond in person to

incoming fax calls. If you want to receive faxes automatically instead, contact your telephone company to subscribe to a distinctive ring service, or to obtain a separate phone line for faxing.

Since your computer dial-up modem shares the phone line with the printer, you cannot use both your modem and the printer simultaneously. For example, you cannot use the printer for faxing if you are using your computer dial-up modem to send an email or access the Internet.

There are two different ways to set up the printer with your computer based on the number of phone ports on your computer. Before you begin, check your computer to see if it has one or two phone ports.

- If your computer has only one phone port, you need to purchase a parallel splitter (also called a coupler), as shown in the illustration. (A parallel splitter has one RJ-11 port on the front and two RJ-11 ports on the back. Do not use a two-line phone splitter, a serial splitter, or a parallel splitter which has two RJ-11 ports on the front and a plug on the back.)



- If your computer has two phone ports, set up the printer as follows:

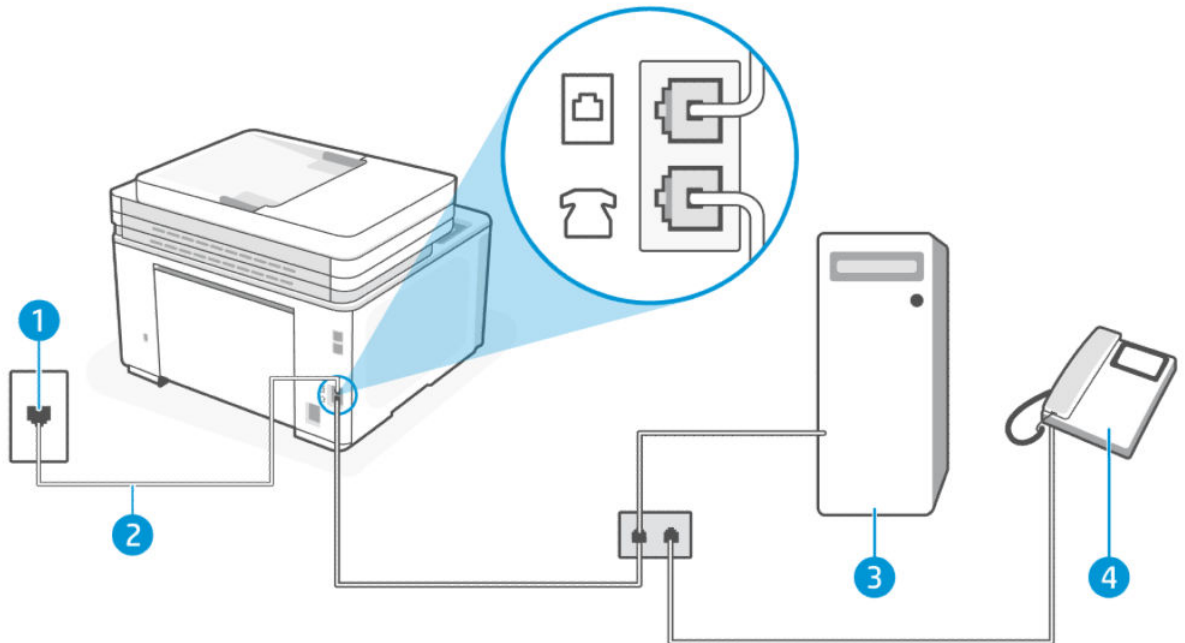





Table 6-16 Back view of the printer

Feature	Description
1	Telephone wall jack.
2	Use a minimum 26 AWG phone cord to connect to the Fax port  on the printer. You might need to connect the phone cord to your country/region adapter.
3	Computer with modem.
4	Telephone.

To set up the printer on the same phone line as a computer with two phone ports

1. Find the phone cord that connects from the back of your computer (your computer dial-up modem) to a telephone wall jack. Disconnect the cord from the telephone wall jack and plug it into the Fax port  on the back of the printer.
2. Connect a phone to the "OUT" port on the back of your computer dial-up modem.
3. Connect one end of the phone cord to your telephone wall jack, then connect the other end to the Fax port  on the back of the printer.



NOTE: You might need to connect the phone cord to your country/region adapter.

4. If your modem software is set to receive faxes to your computer automatically, turn off that setting.



NOTE: If you do not turn off the automatic fax reception setting in your modem software, the printer cannot receive faxes.

5. Touch **Fax, Setup, and Preferences**.
6. Turn off the **Auto Answer** setting.
7. Run a fax test.

You must be available to respond in person to incoming fax calls, or the printer cannot receive faxes.

If you encounter problems setting up the printer with optional equipment, contact your local service provider or vendor for further assistance.

Test fax setup



You can test your fax setup to check the status of the printer and to make sure it is set up correctly for faxing. Perform this test after you have completed setting up the printer for faxing. The test does the following:

- Tests the fax hardware
- Verifies the correct type of phone cord is connected to the printer
- Checks that the phone cord is plugged into the correct port
- Checks for a dial tone
- Checks for an active phone line
- Tests the status of your phone line connection

The printer prints a report with the results of the test. If the test fails, review the report for information on how to fix the problem and rerun the test.

To test fax setup via the printer control panel

1. Set up the printer for faxing according to your home or office setup instructions.
2. Make sure the cartridges are installed, and that full-size paper is loaded in the input tray before starting the test.

3. From the top of the screen, touch or swipe down the tab  to open the Dashboard, and then touch **Setup** .

4. Touch **Fax Setup**.

5. Touch **Tools**, and then touch **Run Fax Test**.

The printer displays the status of the test on the display and prints a report.

6. Review the report.

- If the test passes and you are still having problems faxing, check the fax settings listed in the report to verify the settings are correct. A blank or incorrect fax setting can cause problems faxing.
- If the test fails, review the report for more information on how to fix any problems found.

7 Configure your printer

This section describes how to configure your printer.

Use Web Services

The printer offers innovative, cloud-based solutions, such as print anywhere, scan-and-save to cloud, and other services (including supplies auto replenishment).

For more information, visit the HP Smart website (admin.hpsmart.com).



NOTE: To use these cloud-based solutions, the printer must be connected to the Internet.

Set up Web Services

1. Before setting up Web Services, make sure your printer is connected to the Internet.
2. Open the EWS. See [Configure the printer using the Embedded Web Server \(EWS\)](#).
3. Click the **Web Services** tab.
4. From the left menu, click **Printer Pairing** under **Web Services Settings**.
5. Click **Start Pairing** to pair your printer.
6. If prompted, choose to allow the printer to check for and install printer updates.



NOTE:

- If prompted for a password, enter the PIN from a label in the printer. See [Things to note when accessing EWS](#).
 - If prompted for proxy settings and if your network uses proxy settings, follow the on-screen instructions to set up a proxy server. If you do not have the details, contact your network administrator or the person who set up the network.
 - If prompted for printer updates, allow the printer to continue with the update or manually check for updates from the EWS. Open the EWS, click the **Tools** tab, click **Printer Updates** and **Firmware Updates** from the left menu, and select the desired options.
-
7. After the printer is connected to the HP server, the printer prints an information sheet. Follow the instructions on the information sheet to finish setting up Web Services.

Update the printer

HP offers periodic printer updates to improve printer performance, fix issues, or protect your printer against potential security threats.

When setting up the printer through HP Software, it prompts to update the printer to the latest firmware. Follow the onscreen instructions and update the printer.

You can change the setting to manually check for updates from the embedded web server (EWS). In EWS, click the **Tools** tab, click **Printer Updates** and **Firmware Updates** from the left menu, and select the desired options.

Dynamic Security Enabled Printers

This printer is intended to work only with cartridges that have a new or reused HP chip. A reused HP chip enables the use of reused, remanufactured, and refilled cartridges.

The printer uses dynamic security measures to block cartridges using a non-HP chip. Periodic firmware updates delivered over the internet will maintain the effectiveness of the dynamic security measures and block cartridges that previously worked.

Updates can improve, enhance, or extend the printer's functionality and features, protect against security threats, and serve other purposes, but these updates can also block cartridges using a non-HP chip from working in the printer, including cartridges that work today. Unless you are enrolled in certain HP programs such as Instant Ink or use other services that require automatic online firmware updates, most HP printers can be configured to receive updates either automatically or with a notification that allows you to choose whether to update or not. For more information on dynamic security and how to configure online firmware updates, please go to www.hp.com/learn/ds.

Open the HP printer software (Windows)

After installing the HP printer software, depending on your operating system, do one of the following:

- **Windows 10 and above:** From the computer desktop, click **Start**, select **HP** from the app list, and then select the icon with the printer name.
- **Windows 7:** From the computer desktop, click **Start**, select **All Programs**, click **HP**, click the folder for the printer, and then select the icon with the printer name.



NOTE: Windows 7 Service Pack1 (SP1) is required to install the HP printer software.



NOTE: If you have not installed the HP printer software, visit hp.com/support to download and install the necessary software.

Configure the printer using the Embedded Web Server (EWS)

Use the Embedded Web Server (EWS) to manage printing functions from your computer.

- View printer status information
- Check the information and status of the toner supplies
- Receive notification of printer and supplies events
- View and change the network and the printer settings

To access and use the Embedded Web Server (EWS)

You can open EWS using one of the following:

- HP Smart app
- HP printer software

- Web browser using IP address
- Web browser using Wi-Fi Direct connection

Things to note when accessing EWS

- If the web browser displays a message indicating that the website is unsafe, select the option to continue. Accessing the website will not harm your device.
- For your security, some settings in the printer home page or EWS are password-protected.
 - When accessing the EWS for the first time, enter the PIN if prompted. This personal identification number (PIN) is available from a label in the printer.
 - Open the cartridge access door to locate the label.
 - Once you have access to EWS, you can change the password from EWS.

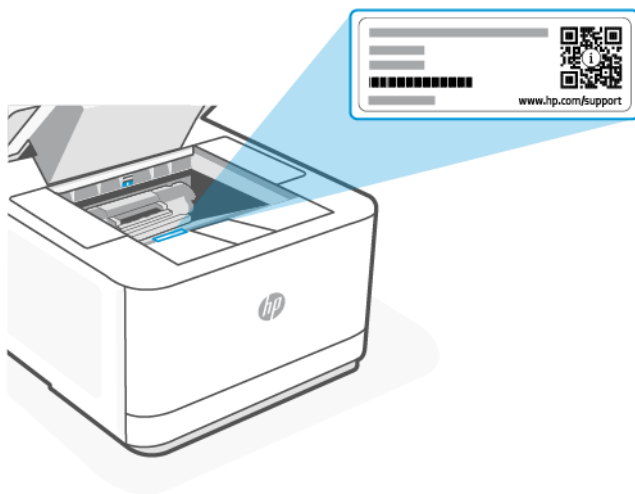

- Depending on how the printer is connected, some features in EWS might not be available.
- EWS is not accessible beyond the network firewall.

To open EWS using HP Smart (iOS, Android, and Windows 10 and above)

1. Open HP Smart app on your computer or mobile device. See [Use the HP Smart app to print, scan, and manage](#).
2. From HP Smart app, select your printer, and then click or tap **Advanced Settings**.

To open EWS using an IP address (Wi-Fi or Ethernet connection)

1. To find out the IP address of the printer, touch or swipe down the tab  at the top of the screen on the control panel to open the Dashboard, and touch the **Info** tab.
2. Open a web browser on your device. Type the IP address (as indicated on the screen or page) in the address bar, and then click or tap **Enter** on your device.

To open EWS using an IP address (Wi-Fi Direct connection)

1. Make sure your device and the printer are connected using Wi-Fi Direct. See [Print without connecting to same Wi-Fi network \(Wi-Fi Direct\)](#).
2. Open a web browser, type the following IP address or hostname of the printer in the address bar, and then click or tap **Enter**.

IP Address/Hostname: 192.168.223.1

To open EWS using HP Printer software (Windows 7)

 **NOTE:** Windows 7 Service Pack1 (SP1) is required to install the HP printer software.

1. From the computer desktop, click **Start**, select **All Programs**, click **HP**, click the folder for the printer, select the icon with the printer's name, and then open **HP Printer Assistant**.
2. In the **HP Printer Assistant**, select **Print** tab.
3. Select **Printer Home Page (EWS)**.

Configure IP network settings

Use the following sections to configure the printer network settings.

If prompted for a password, enter the PIN which is available from a label in the cartridge access area. See [Things to note when accessing EWS](#).

View or change network settings

Use the Embedded Web Server to view or change IP configuration settings.

1. Open the EWS. See [Configure the printer using the Embedded Web Server \(EWS\)](#).
2. Click the **Network** tab to obtain network information. Change settings as needed.

Rename the printer on a network

To rename the printer on a network so that it can be uniquely identified, use the Embedded Web Server.

1. Open the EWS. See [Configure the printer using the Embedded Web Server \(EWS\)](#).
2. Click the **Network** tab.
3. From the left menu, click **General**.
4. Click **Network Identification** and change the hostname.
5. Make any necessary changes and click **Apply**.

Manually configure IPv4 TCP/IP parameters

Use the EWS to manually set an IPv4 address, subnet mask, and default gateway.

1. Open the EWS. See [Configure the printer using the Embedded Web Server \(EWS\)](#).
2. Click the **Network** tab.
3. From the left menu, click **Wired**.

4. Click **IPv4 Configuration** and make the necessary changes.
5. Click **Apply**.

Assign or change the system password using the Embedded Web Server

Assign an administrator password for access to the printer and the HP Embedded Web Server so that unauthorized users cannot change the printer settings.

1. Open the EWS. See [Configure the printer using the Embedded Web Server \(EWS\)](#).
2. Click **Settings** tab.
3. From the left menu, click **Security**.
4. Click **Password Settings** and make the necessary changes.
5. Click **Apply**.

 **NOTE:** Make note of the password and store it in a safe place.

Change energy-conservation settings

The printer includes several economic features to conserve energy and supplies.

Set the Sleep Mode time

Use the EWS to set the amount of idle time before the printer enters sleep mode.

1. Open the EWS. See [Configure the printer using the Embedded Web Server \(EWS\)](#).
2. Click the **Settings** tab.
3. From the left menu, click **Power Management**.
4. Click **Sleep Mode** and select the desired time.
5. Click **Apply**.

Change the printer shutdown time and settings

Use the EWS to set the amount of time before the printer shuts down.

1. Open the EWS. See [Configure the printer using the Embedded Web Server \(EWS\)](#).
2. Click the **Settings** tab.
3. From the left menu, click **Power Management**.
4. Click **Shutdown Mode** and select the desired time.
5. Select or clear the option to delay the shutdown.

 **NOTE:**

- When this option is selected the printer will not shut down unless all ports are inactive. An active network link will prevent the printer from shutting down.
 - The default shutdown time is **4 hours**.
-

6. Click **Apply**.

8 Supplies, accessories, and parts

This section describes how to order supplies and manage accessories.

Dynamic Security Enabled Printers

This printer is intended to work only with cartridges that have a new or reused HP chip. A reused HP chip enables the use of reused, remanufactured, and refilled cartridges.

The printer uses dynamic security measures to block cartridges using a non-HP chip. Periodic firmware updates delivered over the internet will maintain the effectiveness of the dynamic security measures and block cartridges that previously worked.

Updates can improve, enhance, or extend the printer's functionality and features, protect against security threats, and serve other purposes, but these updates can also block cartridges using a non-HP chip from working in the printer, including cartridges that work today. Unless you are enrolled in certain HP programs such as Instant Ink or use other services that require automatic online firmware updates, most HP printers can be configured to receive updates either automatically or with a notification that allows you to choose whether to update or not. For more information on dynamic security and how to configure online firmware updates, please go to www.hp.com/learn/ds.

Order supplies, accessories, and parts

This topic describes how to order supplies, accessories, and parts.

Order

Table 8-1 Order

Order supplies	Support sites
Order supplies and paper	www.hp.com/go/suresupply
Order genuine HP parts or accessories	www.hp.com/buy/parts
Order through service or support providers	Contact an HP-authorized service or support provider.
Order using the HP Embedded Web Server (EWS)	To access, in a supported Web browser on the computer, enter the printer IP address in the address/URL field. The EWS contains a link to the HP SureSupply Web site, which provides options for purchasing Original HP supplies.



NOTE: You can also order using HP Smart. For information about this app, see [Use the HP Smart app to print, scan, and manage.](#)

Supplies and accessories

- A: Standard-capacity black toner cartridge.
- X: High-capacity black toner cartridge.

Table 8-2 List of supplies and accessories

Cartridge name/number	Part number	Countries in use
HP 138A Black Original LaserJet Toner Cartridge	W1380A	North America, Australia, and New Zealand only
HP 138X Black Original LaserJet Toner Cartridge	W1380X	North America, Australia, and New Zealand only
HP 139A Black Original LaserJet Toner Cartridge	W1390A	Europe, Switzerland, UK, Ireland, and Israel only*
HP 139X Black Original LaserJet Toner Cartridge	W1390X	Europe, Switzerland, UK, Ireland, and Israel only*
HP 145A Black Original LaserJet Toner Cartridge	W1450A	Latin America, ISE, Asia Pacific, Africa and the Middle East (except China, India, Australia, and New Zealand) only
HP 145X Black Original LaserJet Toner Cartridge	W1450X	Latin America, ISE, Asia Pacific, Africa and the Middle East (except China, India, Australia, and New Zealand) only
HP 146A Black Original LaserJet Toner Cartridge	W1460A	China and India only
HP 146X Black Original LaserJet Toner Cartridge	W1460X	China and India only

*The product is regionalized for the regions and countries listed above. However, nothing herein must be deemed as an authorization from HP to import products into the European Economic Area, Switzerland, and the UK from any country outside that region.

Configure the HP toner-cartridge-protection supply settings

Use HP Cartridge Policy and Cartridge Protection to control which cartridges are installed in the printer and protect the cartridges that are installed from theft.

- **Cartridge Policy:** This feature protects the printer from counterfeit toner cartridges by allowing only genuine HP cartridges to be used with the printer. Using genuine HP cartridges ensures the best possible print quality. When someone installs a cartridge that is not a genuine HP cartridge, the printer control panel displays a message that the cartridge is unauthorized and it provides information explaining how to proceed.
- **Cartridge Protection:** This feature permanently associates toner cartridges with a specific printer, or fleet of printers, so they cannot be used in other printers. Protecting cartridges protects your investment. When this feature is enabled, if someone attempts to transfer a protected cartridge from the original printer into an unauthorized printer, that printer will not print with the protected cartridge. The printer control panel displays a message that the cartridge is protected, and it provides information explaining how to proceed.

⚠ CAUTION: After enabling cartridge protection for the printer, all subsequent toner cartridges installed in the printer are automatically and *permanently* protected. To avoid protecting a new cartridge, disable the feature *before* installing the new cartridge.

Turning the feature off does not turn off protection for cartridges that are currently installed.

Both features are off by default. Follow these procedures to enable or disable them.

Enable or disable the Cartridge Policy feature

 **NOTE:** Enabling or disabling this feature might require entering an administrator password.

1. Open the EWS. See [Configure the printer using the Embedded Web Server \(EWS\)](#).
2. Click the **Settings** tab.
3. From the left menu, click **Supplies**, and then select **Supply Settings**.
4. Select the desired option under **Cartridge Policy**.
5. Click **Apply**.

Replace the toner cartridge

This section describes how to replace the toner cartridges.

Cartridge information

Continue printing with the current cartridge until redistributing the toner no longer yields acceptable print quality. To redistribute the toner, remove the toner cartridge from the printer and gently rock the cartridge back and forth about its horizontal axis. For graphical representation, see cartridge replacement instructions. Reinsert the toner cartridge into the printer and close the cover.

Remove and replace the toner cartridge

When a toner cartridge approaches the end of useful life, you can continue printing with the current cartridge until redistributing the toner no longer yields acceptable print quality.

1. Open the cartridge access door, and then remove the old cartridge.

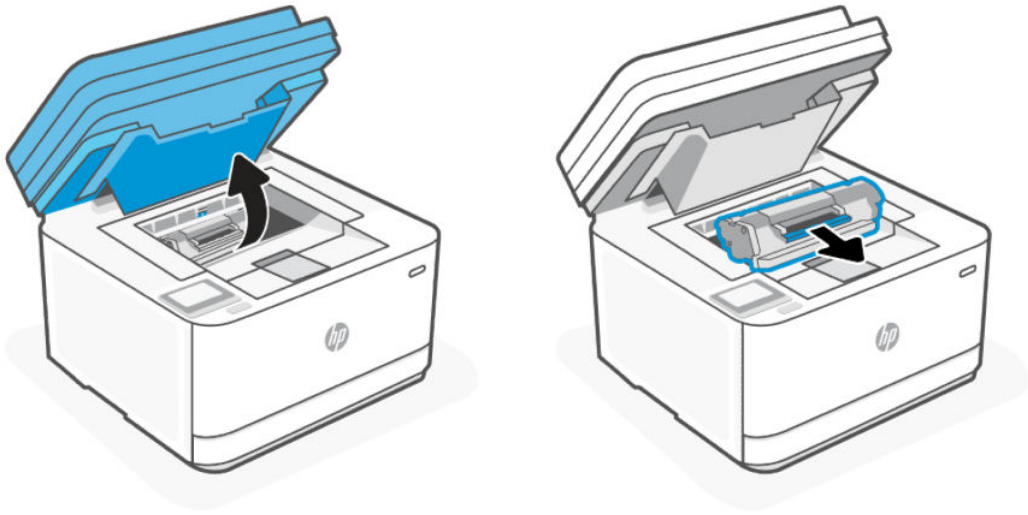

2. Remove the new cartridge from the packaging. Place the used cartridge in the bag and box for recycling.

⚠ CAUTION: To prevent damage to the cartridge, hold the cartridge at each end. Do not touch the protective cover or roller surface.

3. Grasp both sides of the cartridge and gently rock the cartridge to distribute the toner evenly inside the cartridge.

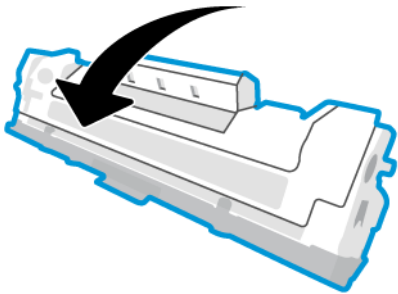

4. Remove the cover from the cartridge.

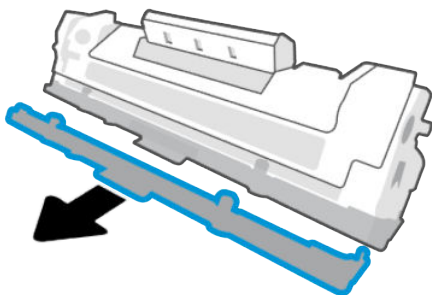

5. Insert the cartridge in the product, and then close the cartridge access door.

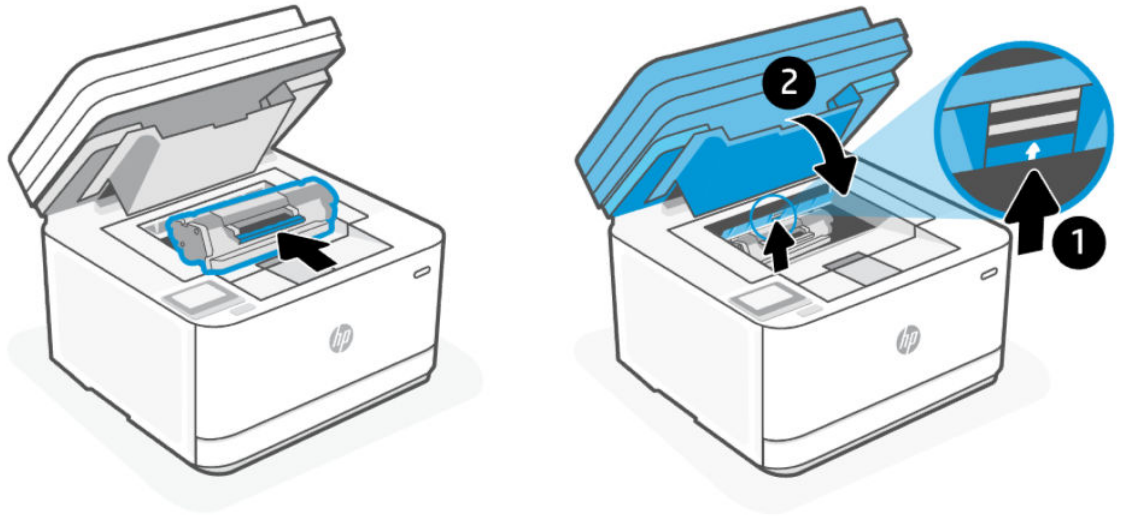

⚠ CAUTION: If toner gets on your clothing, wipe it off with a dry cloth and wash the clothing in cold water. *Hot water sets toner into the fabric.*

9 Solve problems

This section suggests solutions to common problems.

You can also get help from the HP Smart app. HP Smart provides alerts for printer issues (jams and other problems), links to help content, and options to contact support for additional assistance. For more information, see [Use the HP Smart app to print, scan, and manage](#).

If the suggestions do not solve the problems, try getting help using one of the support services, see HP support.

HP support

For the latest product updates and support information, visit hp.com/support and find your printer. HP online support provides a variety of options for help with your printer:

- **Get software and drivers:** Download software, drivers, and firmware you need for the printer.
- **Ask the community:** Join the community forums to find solutions, ask questions, and share tips.
- **HP Diagnostic Tools:** Use HP online tools to detect your printer and find recommended solutions.

Contact HP

If you need help from an HP technical support representative to solve a problem, visit hp.com/support. The following contact options are available at no cost for in-warranty customers (HP agent-assisted support for out-of-warranty customers may require a fee):

- Chat with an HP support agent or the HP Virtual Agent online.
- Call an HP support agent.

When contacting HP support, be prepared to provide the following information:

- Product name (located on the printer)
- Product number (located on a label inside the printer)
- Serial number (located on a label inside the printer)

Register printer

By taking just a few minutes to register, you can enjoy quicker service, more efficient support, and product support alerts. If you did not register your printer while installing the software, you can register now at www.register.hp.com

Additional warranty options

Extended service plans are available for the printer at additional costs. Visit hp.com/support, select your country/region and language, find your printer, and then explore the extended warranty options available for your printer.

Additional information

Go to hp.com/support. Select your country/region. Enter the product name, and then select **Search**.

Instructions are available for performing various tasks, such as the following:

- Troubleshooting your printer
- Printing from various applications, and from various devices
- Obtaining support

You will find documents, videos, and many other resources to help you get the most from your printer.

Print printer reports

This topic describes how to print reports through the EWS and the printer control panel.

To print a report from the printer control panel

1. On the Home screen of the printer display, touch **Setup** .
2. Scroll down and touch **Reports**.
3. Scroll down and select the desired report to print.

To print a report from the EWS

1. Open the EWS. See [Configure the printer using the Embedded Web Server \(EWS\)](#).
2. Click the **Tools** tab.
3. From the left menu, click **Reports**.
4. Click **Printer Reports** to print the desired report.

Printer reports

Table 9-1 Printer reports

Printer report	Description	How to print
Printer Status Report	Printer Status Report includes the current printer information, Supplies status and some recent events. It also helps to troubleshoot problems with the printer.	See To print a report from the printer control panel
Network Configuration Page (wireless models)	Configuration report shows the IP settings, Ports/Services status, a list of Wi-Fi networks in range of the printer. It also includes details for Wi-Fi Direct including SSID name, IP address, Wi-Fi Direct Printing on/off status, Wi-Fi Direct Printing security on/off status, and security pass code.	See To print a report from the printer control panel
Wireless Test Report (wireless models)	Wireless Network Test Report contains diagnostic information, typically used as a troubleshooting aid for the users. The report consists of connection problems that exists between the printer radio/STA and the home network's Wi-Fi router.	See To print a report from the printer control panel
Web Access Test Report	Print the web access report to help identify internet connectivity issues which can affect Web Services.	See To print a report from the printer control panel

Table 9-1 Printer reports (continued)

Printer report	Description	How to print
Web Service Information Page	Depending on the Web Services status, Web Services Reports provide different instructions to help you turn on Web Services, set up Web Services, fix connection issues, and more.	<ol style="list-style-type: none"> 1. Open the EWS. See Configure the printer using the Embedded Web Server (EWS). 2. Click the Web Services tab. 3. From the left menu, click Web Services Settings. 4. Click the Print Info Page to print the information page.
Adjust Alignment Test Page	The printer prints an alignment page.	<ol style="list-style-type: none"> 1. Open the EWS. See Configure the printer using the Embedded Web Server (EWS). 2. Click the Settings tab. 3. From the left menu, click Preferences. 4. Click Image Registration and make the necessary changes. 5. Click Apply.

Restore original factory defaults and settings

This topic describes how to restore original factory defaults and settings. Following are some of the scenarios under which you may want to restore to original factory default settings.

- If you disable some functions or change some settings and want to change them back, you can restore the printer to the original factory settings or network settings.
- If you have made changes to the printer or network settings, you can restore the printer to the original factory settings or network settings.
- If more than two hours have passed since you first turned on the printer and you have not set up the printer wirelessly, place the printer in network setup mode by restoring the printer network settings. The setup mode lasts for two hours.

You can also troubleshoot network connection issues by restoring the printer network settings. If you restore the printer network settings, you need to reconnect the printer to the network.

To restore printer default settings using EWS

1. Open the EWS. See [Configure the printer using the Embedded Web Server \(EWS\)](#).
2. Click the **Settings** tab.
3. From the left menu, click **Restore Defaults**.
4. Select the option to restore factory defaults.
5. Click the button to restore the settings.



The printer automatically restarts.

To restore network default settings using EWS



1. Open the EWS. See [Configure the printer using the Embedded Web Server \(EWS\)](#).
2. Click the **Settings** tab.
3. From the left menu, click **Restore Defaults**.
4. Select the option to restore network settings.
5. Click the button to restore the settings.

The printer automatically restarts.

To restore the printer default settings from the printer control panel

1. On the Home screen of the printer display, touch or swipe down the tab  at the top of the screen to open the Dashboard, and then touch **Setup** .
2. Touch **Printer Maintenance**.
3. Touch **Restore**.
4. Select the desired option or settings to restore.
A message appears stating that the settings will be restored.
5. Touch the button to restore or continue.

To restore the printer network settings from the printer control panel

1. On the Home screen of the printer display, touch or swipe down the tab  at the top of the screen to open the Dashboard, and then touch **Setup** .
2. Touch **Network Setup**.
3. Touch **Restore Network Settings**, and then follow the onscreen instructions.

NOTE:

- You can print the network configuration page and verify that the network settings have been reset.
 - When you reset the printer network settings, previously configured network settings (such as the link speed or IP address) are removed.
The IP address is set back to the Automatic mode.
 - You can visit hp.com/support for information and utilities that can help you correct many common printer problems.
 - (Windows) Run the [HP Print and Scan Doctor](#) to diagnose and automatically fix printing issues. The application is only available in some languages.
-

Cartridge low

This topic describes how to manage the cartridges at low and very low settings.

Cartridge is low

Actual cartridge life remaining may vary. Consider having a replacement available to install when print quality is no longer acceptable. The cartridge does not need to be replaced now.

Continue printing with the current cartridge until redistributing the toner no longer yields acceptable print quality. To redistribute the toner, remove the toner cartridge from the printer and gently rock the cartridge back and forth about its horizontal axis. For graphical representation, see cartridge replacement instructions. Reinsert the toner cartridge into the printer and close the cover.

Cartridge is very low

Actual cartridge life remaining may vary. Consider having a replacement available to install when print quality is no longer acceptable. The cartridge does not need to be replaced now unless the print quality is no longer acceptable.

Once an HP toner cartridge has reached Very Low, HP's Premium Protection Warranty on that toner cartridge has ended.

Change the "Very Low" settings

To change printer supplies settings using EWS

You can change the way the printer reacts when supplies reach the Very Low state. You do not have to re-establish these settings when you install a new toner cartridge.

1. Open the EWS. See [Configure the printer using the Embedded Web Server \(EWS\)](#).
2. Click the **Settings** tab.
3. From the left menu, click **Supplies**.
4. Click **Supply Settings** and select the desired options.
5. Click **Apply**.

Order supplies

Table 9-2 Order supplies

Order	HP Support
Order supplies and paper	www.hp.com/go/suresupply
Order through service or support providers	Contact an HP-authorized service or support provider.
Order using the HP Embedded Web Server (EWS)	To access, in a supported on your computer, enter the printer IP address in the address/URL field. The EWS contains a link to the HP SureSupply website, which provides options for purchasing Original HP supplies.

Paper misfeeds and pickup error

This topic describes how to troubleshoot the paper misfeed issues.

The printer does not pick up paper

If the printer does not pick up paper from the input tray, try these solutions.

1. Open the printer and remove any jammed sheets of paper.
2. Load the tray with the correct size of paper for your job.
3. Make sure the paper size and type are set correctly.
4. Make sure the paper guides in the tray are adjusted correctly for the size of paper. Adjust the guides to the appropriate indentation in the tray.



NOTE: If the problem persists, visit hp.com/support and find your printer to learn more about solving paper problems.

The printer picks up multiple sheets of paper

If the printer picks up multiple sheets of paper from the input tray, try these solutions.

1. Remove the stack of paper from the input tray and rotate it 180 degrees and flip it over. Return the stack of paper to the input tray.
2. Use only paper that meets HP specifications for this product.
3. Use paper that is not wrinkled, folded, or damaged. If necessary, use paper from a different package.
4. Make sure the input tray is not overfilled. If it is, remove the entire stack of paper from the tray, straighten the stack, and then return some of the paper to the input tray.
5. Make sure the paper guides in the tray are adjusted correctly for the size of paper. Adjust the guides to the appropriate indentation in the tray.
6. Make sure the printing environment is within recommended specifications.

The printer picks up paper in a crossed manner

If the printer picks up sheets in a crossed or slightly tilted manner, try these solutions.

1. Pull the input tray out completely.
2. Adjust both the left and right guides using your fingers and ensure that paper is evenly touching the end of the input tray.
3. Insert the input tray back into position.

Clear paper jams

This topic helps you troubleshoot jams and paper-feed issues.

Introduction

The following information includes instructions for clearing paper jams from the printer.

Before you begin

CAUTION:

- Jams can occur in more than one location.
- Do not use sharp objects, such as tweezers or needle-nose pliers, to remove jams. Damage caused by sharp objects will not be covered by the warranty.

- When removing jammed media, pull the jammed media straight away from the product. Pulling jammed media out of the product at an angle can damage the product.
- Use both hands to remove jammed paper to avoid tearing the paper.

Jam locations

Jams can occur at the following locations in the product.

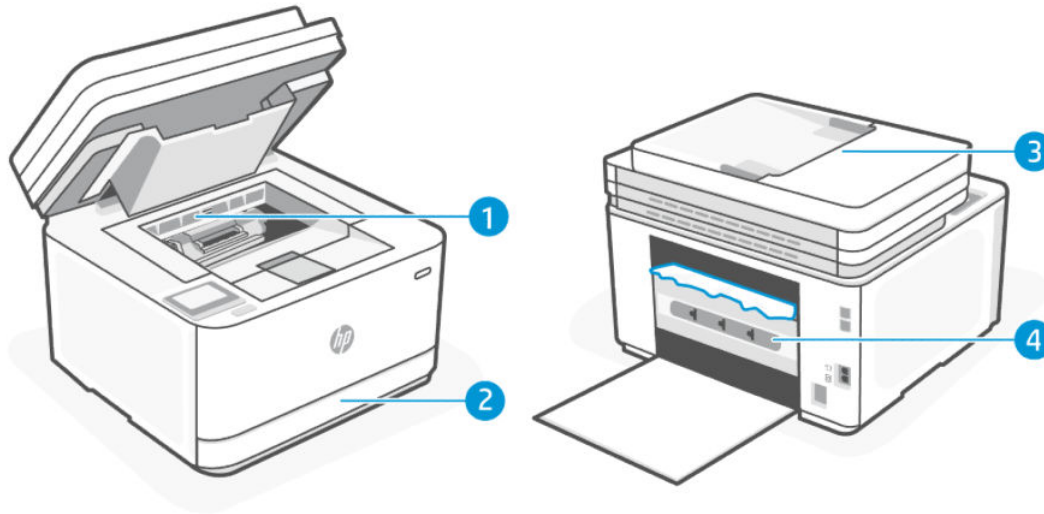

Table 9-3 Jam locations

Feature	Description
1	Cartridge access area
2	Input tray
3	Document feeder
4	Rear access door

Frequent or recurring paper jams?

Follow these steps to solve problems with frequent paper jams. If the first step does not resolve the problem, continue with the next step until you have resolved the problem.

1. If paper has jammed in the printer, clear the jam and then print a test page to test the printer.
2. Check that the tray is configured for the correct paper size and type.
 - a. Open the EWS. See [Configure the printer using the Embedded Web Server \(EWS\)](#).
 - b. Click the **Settings** tab.
 - c. From the left menu, click **Preferences**.
 - d. Click **Tray** and **Paper Management** and check the settings.
3. Turn the printer off, wait 30 seconds, and then turn it on again.

4. [Print a cleaning page](#) to remove excess toner from inside the printer.
5. Print a test page to test the printer.

If none of these steps resolves the problem, the printer might need service. Contact support.

Clear jams from the input tray

1. Remove the input tray.

Pull out the tray fully, and if needed, slightly tilt or lift the tray to remove it from the printer.

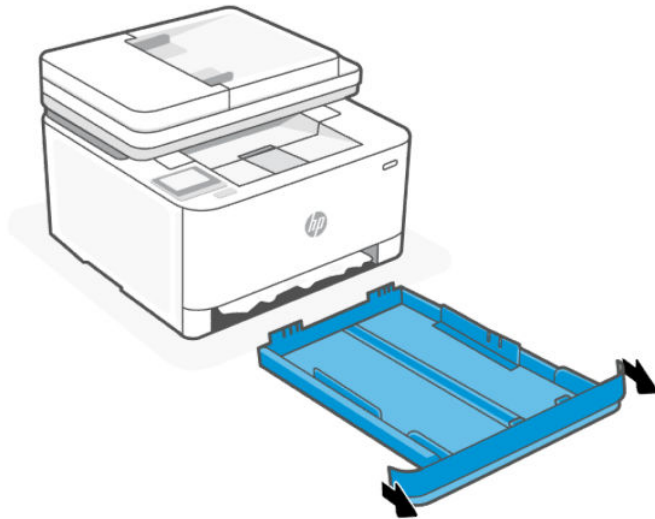

2. Check the input tray area underneath the printer. Remove the jammed paper.

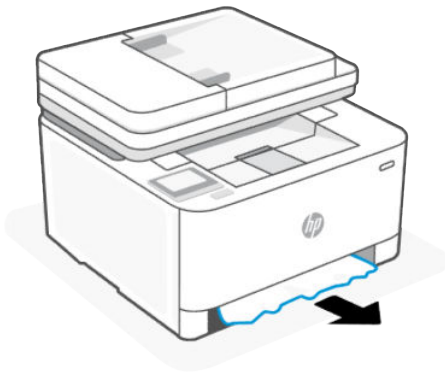

3. Re-insert the input tray back until it snaps into place.

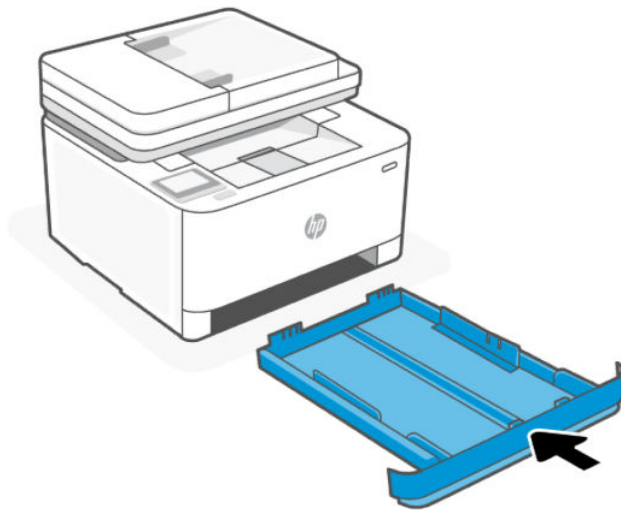

Clear jams from the cartridge access area

1. Open the cartridge access door.

 **NOTE:** Depending on where the jam is located, some of the following steps might not be necessary.

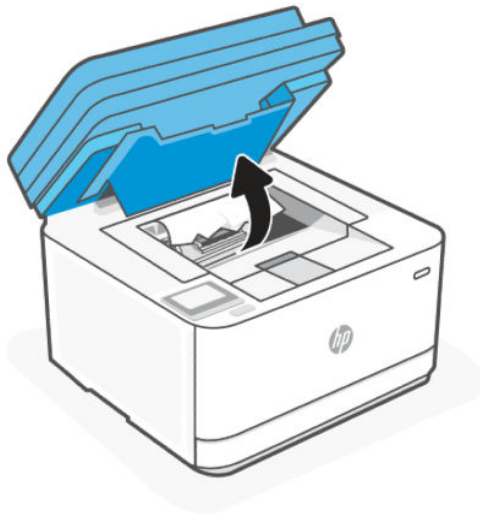

2. Before removing the cartridge, remove any jammed paper in the output tray area. If you can see the jammed paper, carefully grasp the jammed paper, and slowly pull it out of the output tray area.

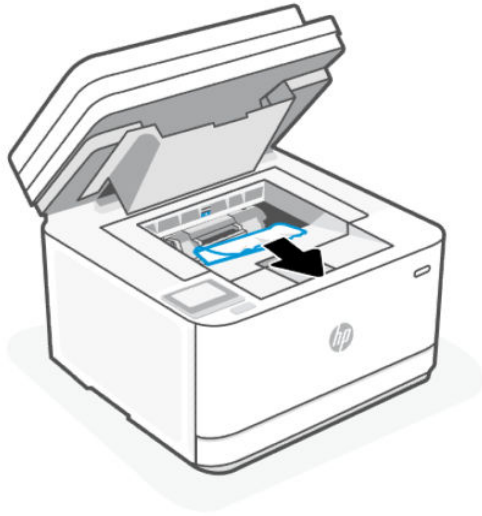

3. Release the lever and pull out the jammed paper.

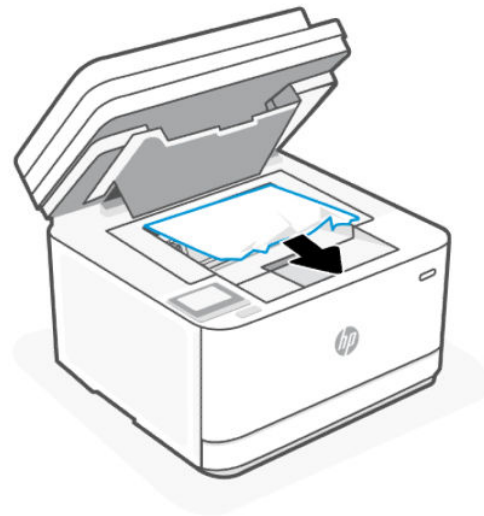
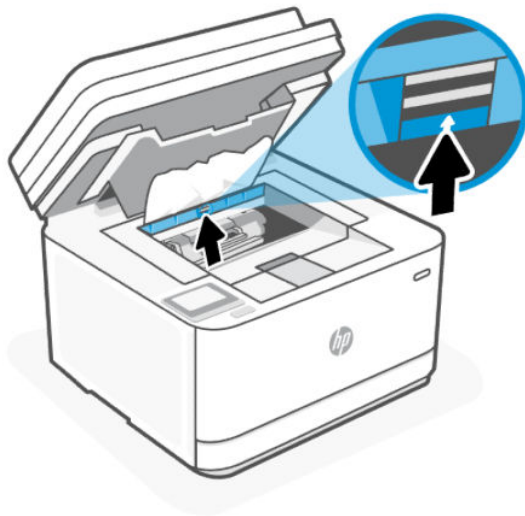

4. Remove the toner cartridge and pull out any jammed paper.

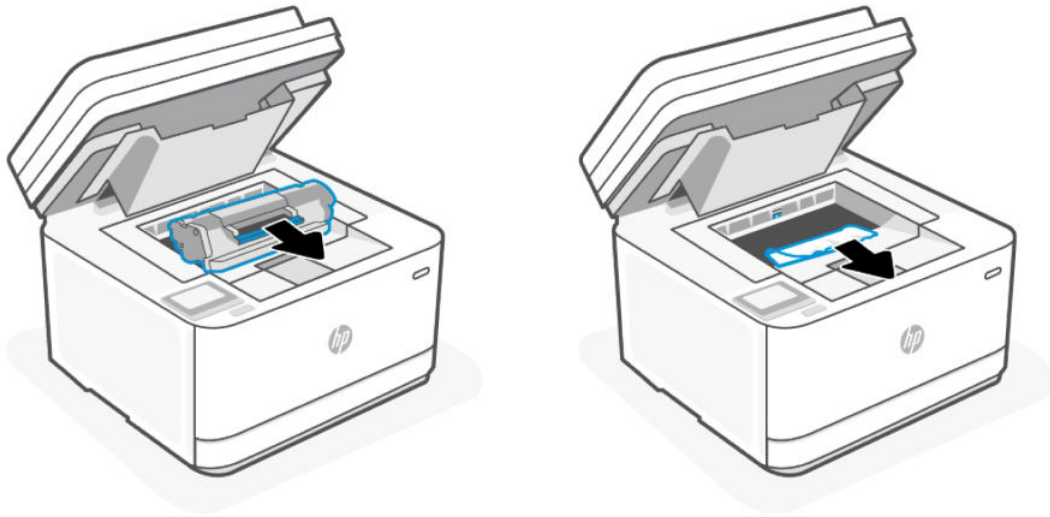

5. Reinstall the toner cartridge, lock the lever, and then close the cartridge access door.

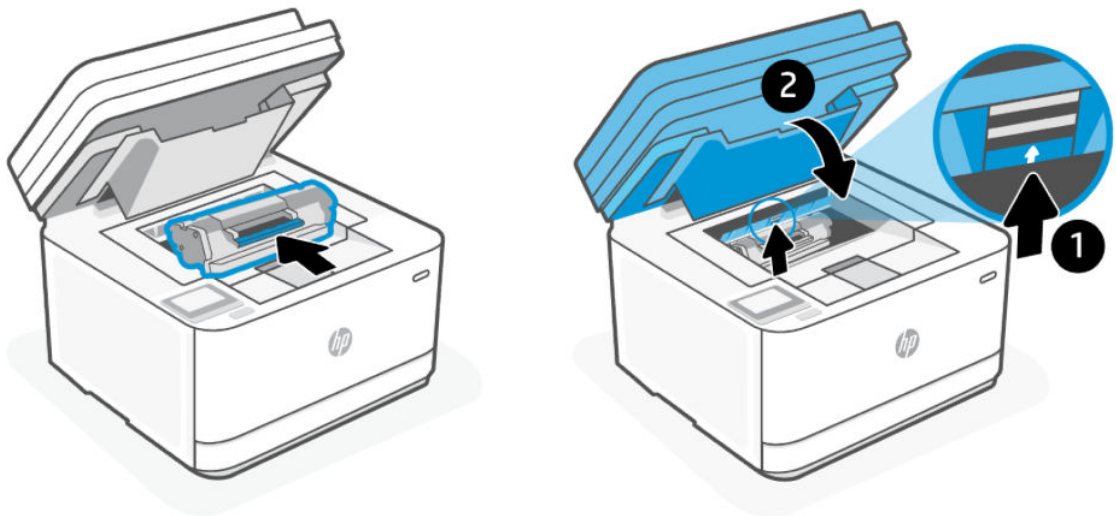

Clear jams in the document feeder

1. Open the document feeder cover.



2. Remove any jammed paper. Use both hands to remove jammed paper to avoid tearing the paper.



3. Close the document feeder cover.



Clear jams from the rear of the printer

1. Open the rear access door.

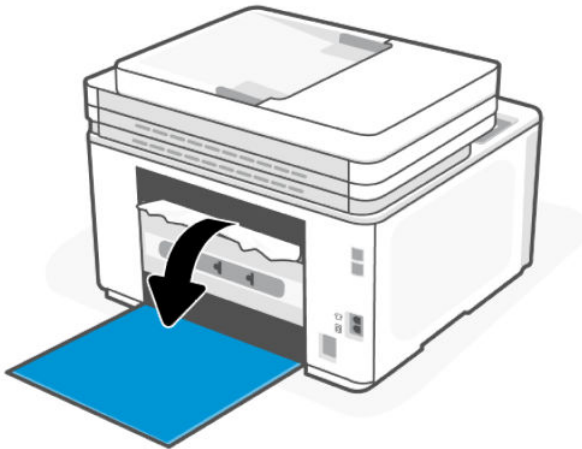

2. If you can see the jammed paper, carefully grasp the jammed paper, and then slowly pull it out of the printer.

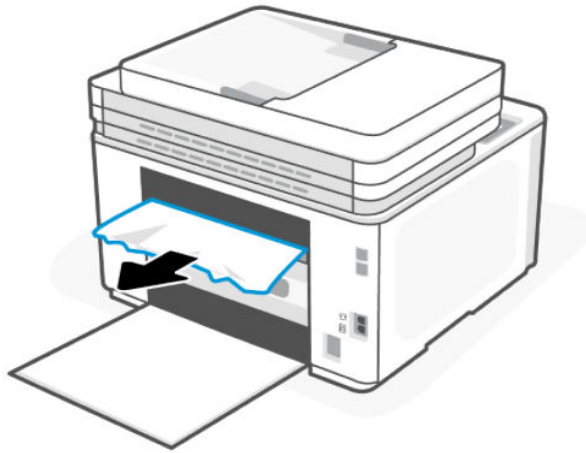

3. Close the rear access door.

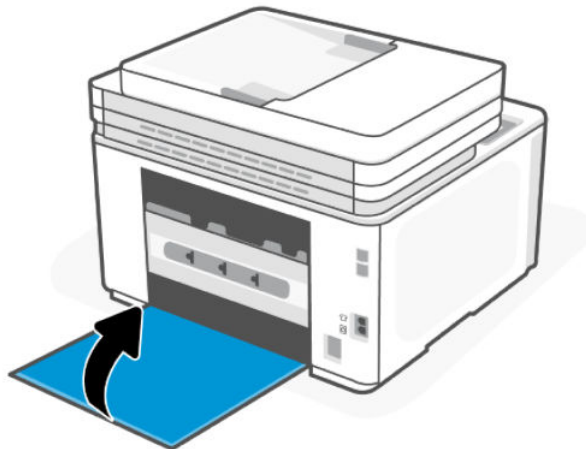

Improve print quality

This topic helps you troubleshoot print quality issues.

Introduction

The following information provides troubleshooting steps to resolve print-quality problems, including the following problems:

- Smears
- Fuzzy print
- Dark print
- Light print
- Streaks

- Missing toner
- Scattered dots of toner
- Loose toner
- Skewed images

To resolve these or other print-quality problems, try the following solutions in the order presented.

For information about resolving specific image defects, see [Resolving print quality problems](#).

Print from a different software program

Try printing from a different software program. If the page prints correctly, the problem is with the software program from which you were printing.

If the page does not print correctly, try updating the printer and print again. See [Update the printer](#).

Check the paper-type setting for the print job

Check the paper type setting when printing from a software program and the printed pages have smears, fuzzy or dark print, curled paper, scattered dots of toner, loose toner, or small areas of missing toner.

Check the paper type setting on the printer

Verify that the tray is loaded with the correct type of paper.

Check the paper type setting (Windows)

1. From the software program, select the **Print** option.
2. Select the printer, and then click the **Set Preferences** button.
3. Check the paper settings.

Check the paper type setting (OS X)

1. Click the **File** menu, and then click the **Print** option.
2. In the **Printer** menu, select the printer.
3. By default, the print driver displays the **Copies & Pages** menu. Open the menus drop-down list, and then click the **Finishing** menu.
4. Select a type from the **Media Type** drop-down list.

Check toner-cartridge status

Print quality problems can occur when using a toner cartridge that is at its estimated end of life. The configuration report indicates when a supply level is very low.

Once an HP toner cartridge has reached Very Low, HP's Premium Protection Warranty on that toner cartridge has ended.

The toner cartridge does not need to be replaced now unless the print quality is no longer acceptable. Consider having a replacement available to install when print quality is no longer acceptable.

The information page provides information about the printer, its connectivity, supplies status, and replacement cartridge number.

1. Check the supplies status from the EWS or the printer control panel. From the printer control panel, touch or swipe down the tab  at the top of the screen to open the Dashboard, and then touch **Toner**. Open EWS, see [Configure the printer using the Embedded Web Server \(EWS\)](#).

2. Check to see if you are using a genuine HP cartridge.

A genuine HP toner cartridge has “HP” on it or has the HP logo on it. For more information on identifying HP cartridges go to www.hp.com/go/learnaboutsupplies

Print a cleaning page

During the printing process paper, toner, and dust particles can accumulate inside the printer and can cause print-quality issues such as toner specks or spatter, smears, streaks, lines, or repeating marks.

Use the following procedure to print a cleaning page from EWS.

1. Open the EWS. See [Configure the printer using the Embedded Web Server \(EWS\)](#).
2. Click the **Tools** tab.
3. From the left menu, click **Utilities** and select **Print Quality Toolbox**.
4. In the **Clean the Fuser** area, click **Start** to begin the cleaning process.

Visually inspect the toner cartridge

Follow these steps to inspect the toner cartridge.

1. Remove the toner cartridge from the printer and verify that the sealing tape has been removed.
2. Check the memory chip for damage.
3. If you see any damage on the toner cartridge, replace the toner cartridge.
4. Reinstall the toner cartridge and print a few pages to see if the problem is resolved.

Check paper and the printing environment

This topic describes how to troubleshoot the paper quality issues and the printing environment.

Step one: Use paper that meets HP specifications

Some print-quality problems arise from using paper that does not meet HP specifications.

- Always use a paper type and weight that this printer supports.
- Use paper that is of good quality and free of cuts, nicks, tears, spots, loose particles, dust, wrinkles, voids, staples, and curled or bent edges.
- Use paper that has not been previously printed on.
- Use paper that does not contain metallic material, such as glitter.
- Use paper that is designed for use in laser printers. Do not use paper that is designed only for use in Inkjet printers.
- Use paper that is not too rough. Using smoother paper generally results in better print quality.

Step two: Check the environment

The environment can directly affect print quality and is a common cause for print-quality or paper-feeding issues. Try the following solutions:

- Move the printer away from drafty locations, such as open windows or doors, or air-conditioning vents.
- Make sure the printer is not exposed to temperatures or humidity outside of printer specifications.
- Do not place the printer in a confined space, such as a cabinet.
- Place the printer on a sturdy, level surface.
- Remove anything that is blocking the vents on the printer. The printer requires good air flow on all sides, including the top.
- Protect the printer from airborne debris, dust, steam, grease, or other elements that can leave residue inside the printer.

Adjust Print Density

Complete the following steps to adjust the print density.

1. Open the EWS. See [Configure the printer using the Embedded Web Server \(EWS\)](#).
2. Click the **Settings** tab.
3. From the left menu, click **Preferences**.
4. Click **General Printer Settings**, and then click **Advanced**.
5. Make the necessary changes under **Print Density**, and then click **Apply**.

Resolving print quality problems

This topic describes how to troubleshoot the image defect issues.

Introduction

The following information provides troubleshooting steps for solving image defect issues, including the following defects:

- Light print
- Gray background or dark print
- Blank pages
- Black pages
- Dark or light bands
- Dark or light streaks
- Missing toner
- Skewed images
- Colors that do not align

- Curled paper

Troubleshoot print quality problems

Table 9-4 Image defects table quick reference

Image defects	Image defects	Image defects
<p>Table 9-5 Light print</p> 	<p>Table 9-6 Gray background or dark print</p> 	<p>Table 9-7 Blank page — No print</p> 
<p>Table 9-8 Black page</p> 	<p>Table 9-9 Banding defects</p> 	<p>Table 9-10 Streak defects</p> 
<p>Table 9-11 Fixing/fuser defects</p> 	<p>Table 9-12 Image placement defects</p> 	<p>Table 9-13 Output defects</p> 

Image defects, no matter the cause, can often be resolved using the same steps. Use the following steps as a starting point for solving image defect issues.

1. Reprint the document. Print quality defects can be intermittent in nature or can go away completely with continued printing.
2. Check the condition of the cartridge. If a cartridge is in a **Very Low** state (it has passed the rated life), replace the cartridge.
3. Make sure that the driver and tray print mode settings match the media that is loaded in the tray. Try using a different ream of media or a different tray. Try using a different print mode.
4. Make sure that the printer is within the supported operating temperature/humidity range.
5. Make sure that the paper type, size, and weight are supported by the printer. For a list of the supported paper sizes and types for the printer, visit hp.com/support and find your printer.



NOTE: The term “fusing” refers to the part of the printing process where toner is affixed to paper.

The following examples depict letter-size paper that has passed through the printer short-edge first.

Table 9-5 Light print



Description	Sample	Possible solutions
<p>Light print:</p> <p>The printed content on the entire page is light or faded.</p>		<ol style="list-style-type: none"> 1. Reprint the document. 2. Remove the cartridge, and then shake it to redistribute the toner. 3. Make sure that the cartridge is installed correctly. 4. Check the supplies status from the EWS or the printer control panel. From the printer control panel, touch or swipe down the tab  at the top of the screen to open the Dashboard, and then touch Toner. Open EWS. See Configure the printer using the Embedded Web Server (EWS). 5. Replace the toner cartridge. 6. Visit hp.com/support if the problem persists.

Table 9-6 Gray background or dark print

Description	Sample	Possible solutions
<p>Gray background or dark print:</p> <p>The image or text is darker than expected.</p>		<ol style="list-style-type: none"> 1. Make sure that the paper in the trays has not already been run through the printer. 2. Use a different paper type. 3. Reprint the document. 4. Mono models only: From the printer EWS, go to the Adjust Toner Density menu, and then adjust the toner density to a lower level. 5. Make sure that the printer is within the supported operating temperature and humidity range. 6. Replace the toner cartridge. 7. Visit hp.com/support if the problem persists.

Table 9-7 Blank page — No print

Description	Sample	Possible solutions
<p>Blank page — No print:</p> <p>The page is completely blank and contains no printed content.</p>		<ol style="list-style-type: none"> 1. Make sure that the cartridge is genuine HP cartridges. 2. Make sure that the cartridge is installed correctly. 3. Print with a different cartridge. 4. Check the paper type in the paper tray and adjust the printer settings to match. If necessary, select a lighter paper type. 5. Visit hp.com/support if the problem persists.

Table 9-8 Black page

Description	Sample	Possible solutions
<p>Black page:</p> <p>The entire printed page is black.</p>		<ol style="list-style-type: none"> 1. Visually inspect the toner cartridge to check for damage. 2. Make sure that the cartridge is installed correctly. 3. Replace the toner cartridge. 4. Visit hp.com/support if the problem persists.

Table 9-9 Banding defects

Description	Sample	Possible solutions
<p>Repetitive wide-pitch banding and Impulse bands:</p> <p>Dark or light lines which repeat down the length of the page. They might be sharp or soft in nature. The defect displays only in areas of fill, not in text or sections with no printed content.</p>		<ol style="list-style-type: none"> 1. Reprint the document. 2. Replace the toner cartridge. 3. Use a different paper type. 4. Visit hp.com/support if the problem persists.

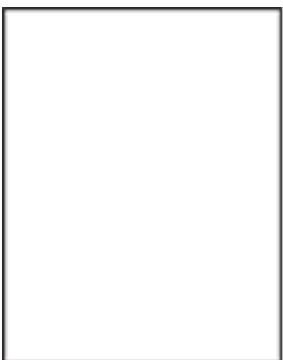
Table 9-10 Streak defects

Description	Sample	Possible solutions
<p>Light vertical streaks:</p> <p>Light streaks that usually span the length of the page. The defect displays only in areas of fill, not in text or sections with no printed content.</p>		<ol style="list-style-type: none"> 1. Reprint the document. 2. Remove the cartridge, and then shake it to redistribute the toner. 3. Visit hp.com/support if the problem persists. <p>NOTE: Both light and dark vertical streaks can occur when the printing environment is outside the specified range for temperature or humidity. Refer to your printer's environmental specifications for allowable temperature and humidity levels.</p>

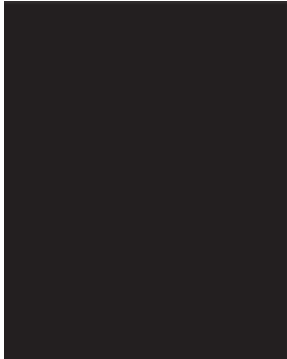
Table 9-10 Streak defects (continued)

Description	Sample	Possible solutions
<p>Dark vertical streaks and ITB cleaning streaks:</p> <p>Dark lines which occur down the length of the page. The defect might occur anywhere on the page, in areas of fill or in sections with no printed content.</p>		<ol style="list-style-type: none"> 1. Reprint the document. 2. Remove the cartridge, and then shake it to redistribute the toner. 3. Print a cleaning page. 4. Check the toner level in the cartridge. See Configure the printer using the Embedded Web Server (EWS). 5. Visit hp.com/support if the problem persists.

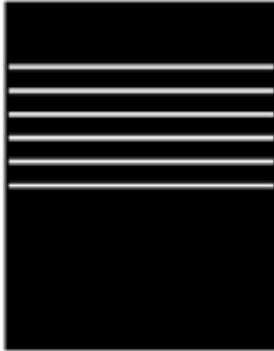
Table 9-11 Fixing/fuser defects



Description	Fixing/fuser	Possible solutions
<p>Hot fuser offset (shadow):</p> <p>Slight shadows, or offsets, of the image repeated down the page. The repeated image might fade with each recurrence.</p>		<ol style="list-style-type: none"> 1. Reprint the document. 2. Check the paper type in the paper tray and adjust the printer settings to match. If necessary, select a lighter paper type. 3. Visit hp.com/support if the problem persists.
<p>Poor fusing:</p> <p>Toner rubs off along either edge of page. This defect is more common at the edges of high-coverage jobs and on light media types but can occur anywhere on the page.</p>		<ol style="list-style-type: none"> 1. Reprint the document. 2. Check the paper type in the paper tray and adjust the printer settings to match. If necessary, select a heavier paper type. 3. Visit hp.com/support if the problem persists.

Table 9-12 Image placement defects

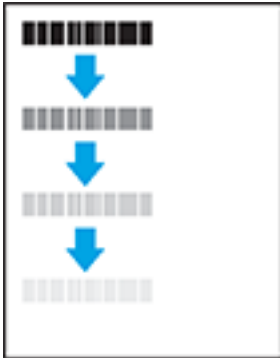

Description	Sample	Possible solutions
<p>Margins and skew:</p> <p>The image is not centered or is skewed on the page. The defect occurs when the paper is not positioned properly as it is pulled from the tray and moves through the paper path.</p>		<ol style="list-style-type: none"> 1. Reprint the document. 2. Remove the paper and then reload the tray. Make sure that all the paper edges are even on all sides. 3. Make sure that the top of the paper stack is below the tray full indicator. Do not overfill the tray. 4. Make sure that the paper guides are adjusted to the correct size for the paper. Do not adjust the paper guides tightly against the paper stack. Adjust them to the indentations or markings in the tray. 5. Visit hp.com/support if the problem persists.

Table 9-13 Output defects

Description	Sample	Possible solutions
<p>Output curl:</p> <p>Printed paper has curled edges. The curled edge can be along the short or long side of the paper. Two types of curl are possible:</p> <ul style="list-style-type: none"> • Positive curl: The paper curls toward the printed side. The defect occurs in dry environments or when printing high coverage pages. • Negative curl: The paper curls away from the printed side. The defect occurs in high-humidity environments or when printing low coverage pages. 		<ol style="list-style-type: none"> 1. Reprint the document. 2. Positive curl: From the printer EWS, select a heavier paper type. The heavier paper type creates a higher temperature for printing. Negative curl: From the printer EWS, select a lighter paper type. The lighter paper type creates a lower temperature for printing. Try storing the paper in a dry environment prior or use freshly opened paper. 3. Print in duplex mode. 4. Visit hp.com/support if the problem persists.
<p>Output stacking:</p> <p>The paper does not stack well in the output tray. The stack might be uneven, skewed, or the pages might be pushed out of the tray and onto the floor. Any of the following conditions can cause this defect:</p> <ul style="list-style-type: none"> • Extreme paper curl • The paper in the tray is wrinkled or deformed • The paper is a non-standard paper type, such as envelopes • The output tray is too full 		<ol style="list-style-type: none"> 1. Reprint the document. 2. Extend the output bin extension. 3. If the defect is caused by extreme paper curl, complete the troubleshooting steps for Output curl. 4. Use a different paper type. 5. Use freshly opened paper. 6. Remove the paper from the output tray before the tray gets too full. 7. Visit hp.com/support if the problem persists.

Fax issues

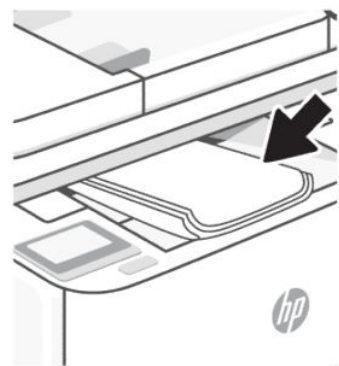
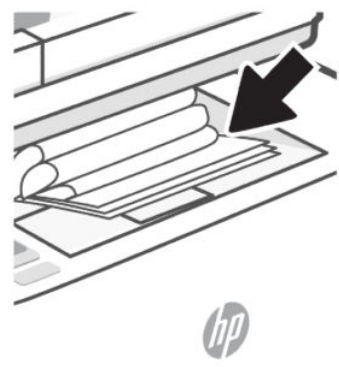
Run the fax test report first to see if there is a problem with your fax setup. If the test passes and you are still having problems faxing, check the fax settings listed in the report to verify that the settings are correct.

 **NOTE:** This section is applicable only for models that have fax enabled.

Run the fax test

You can test your fax setup to check the status of the printer and to make sure it is set up correctly for faxing. Perform this test only after you have completed fax setup on the printer. The test does the following:

- Tests the fax hardware
- Verifies that the correct type of phone cord is connected to the printer
- Checks that the phone cord is plugged into the correct port
- Checks for a dial tone
- Tests the status of your phone line connection
- Checks for an active phone line

To test fax setup via the printer control panel

1. Set up the printer for faxing according to your home or office setup instructions.
2. Make sure the cartridges are installed and that full-size paper is loaded in the input tray before starting the test.
3. On the **Fax** screen, flick to the right and touch **Setup**, touch **Setup Wizard**, and then follow the onscreen instructions.

The printer displays the status of the test on the display and prints a report.

4. Review the report.
 - If the fax test failed, review the solutions below.
 - If the fax test passed and you are still having problems faxing, verify that the fax settings listed in the report are correct. You can also use HP's online troubleshooting wizard.

What to do if the fax test failed

If you ran a fax test and the test failed, review the report for basic information about the error. For more detailed information, check the report to see which part of the test failed, and then review the appropriate topic in this section for solutions to try.

The "Fax Hardware Test" failed

- Turn the printer off by pressing the Power button  located on the front left side of the printer and then unplug the power cord from the back of the printer. After a few seconds, plug the power cord in again, and then turn the power on. Run the test again. If the test fails again, continue reviewing the troubleshooting information in this section.
- Try to send or receive a test fax. If you can send or receive a fax successfully, there might not be a problem.

- If you are running the test from the **Fax Setup Wizard** (Windows), make sure the printer is not busy completing another task, such as receiving a fax or making a copy. Check the display for a message indicating that the printer is busy. If it is busy, wait until it is finished and in the idle state before running the test.
- If you are using a phone splitter, this can cause faxing problems. (A splitter is a two-cord connector that plugs into a telephone wall jack.) Try removing the splitter and connecting the printer directly to the telephone wall jack.

After you resolve any problems found, run the fax test again to make sure it passes and the printer is ready for faxing. If the **Fax Hardware Test** continues to fail and you experience problems faxing, contact HP support. Go to hp.com/support. This website provides information and utilities that can help you correct many common printer problems. If prompted, select your country/region, and then click **All HP Contacts** for information on calling for technical support.

The "Fax Connected to Active Telephone Wall Jack" test failed

- Check the connection between the telephone wall jack and the printer to make sure the phone cord is secure.
- Connect one end of the phone cord to your telephone wall jack, then connect the other end to the Fax port  on the back of the printer.
- If you are using a phone splitter, this can cause faxing problems. (A splitter is a two-cord connector that plugs into a telephone wall jack.) Try removing the splitter and connecting the printer directly to the telephone wall jack.
- Try connecting a working phone and phone cord to the telephone wall jack that you are using for the printer and check for a dial tone. If you do not hear a dial tone, contact your telephone company and have them check the line.
- Try to send or receive a test fax. If you can send or receive a fax successfully, there might not be a problem.



After you resolve any problems found, run the fax test again to make sure it passes and the printer is ready for faxing.

The "Phone Cord Connected to Correct Port on Fax" test failed

If you are using a phone splitter, this can cause faxing problems. (A splitter is a two-cord connector that plugs into a telephone wall jack.) Try removing the splitter and connecting the printer directly to the telephone wall jack.

Plug the phone cord into the correct port

1. Connect one end of the phone cord to your telephone wall jack, then connect the other end to the Fax port  on the back of the printer.

 **NOTE:** If you use the Fax port  to connect to the telephone wall jack, you cannot send or receive faxes. The Fax port  should only be used to connect other equipment, such as an answering machine.

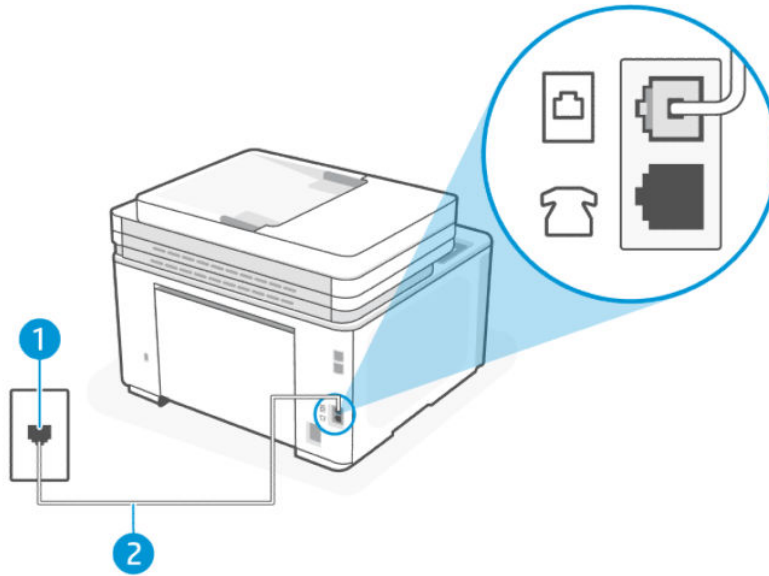



Table 9-14 Back view of the printer

Feature	Description
1	Telephone wall jack.
2	Use a minimum 26 AWG phone cord to connect to the Fax port  on the printer.

2. After you have connected the phone cord to the Fax port , run the fax test again to make sure it passes and the printer is ready for faxing.
3. Try to send or receive a test fax.

The "Using Correct Type of Phone Cord with Fax" test failed

- Connect one end of the phone cord to your telephone wall jack, then connect the other end to the Fax port  on the back of the printer.

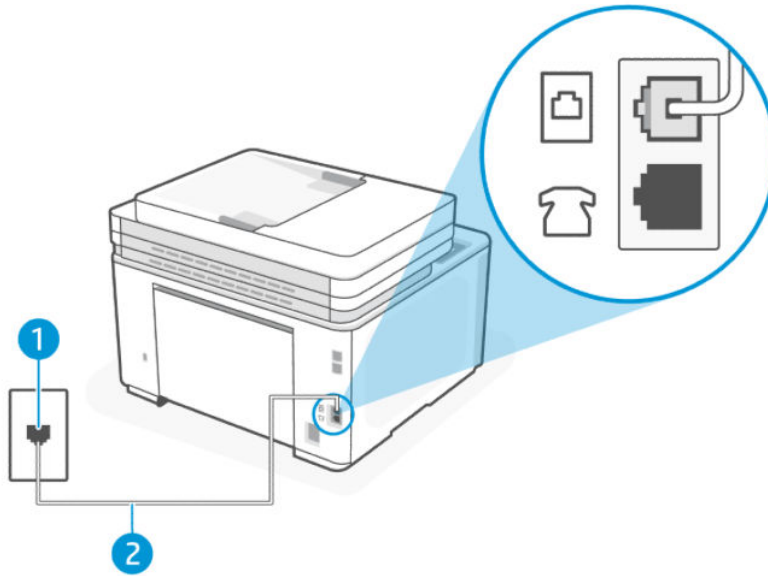



Table 9-15 Back view of the printer

Feature	Description
1	Telephone wall jack.
2	Use a minimum 26 AWG phone cord to connect to the Fax port  on the printer.

- Check the connection between the telephone wall jack and the printer to make sure the phone cord is secure.
- If you are using a phone splitter, this can cause faxing problems. (A splitter is a two-cord connector that plugs into a telephone wall jack.) Try removing the splitter and connecting the printer directly to the telephone wall jack.

The "Dial Tone Detection" test failed

- Other equipment, which uses the same phone line as the printer, might be causing the test to fail. To find out if other equipment is causing a problem, disconnect everything from the phone line, and then run the test again. If the **Dial Tone Detection Test** passes without the other equipment, then one or more pieces of the equipment is causing problems; try adding them back one at a time and rerunning the test each time, until you identify which piece of equipment is causing the problem.
- Try connecting a working phone and phone cord to the telephone wall jack that you are using for the printer and check for a dial tone. If you do not hear a dial tone, contact your telephone company and have them check the line.
- Connect one end of the phone cord to your telephone wall jack, then connect the other end to the Fax port  on the back of the printer.
- If you are using a phone splitter, this can cause faxing problems. (A splitter is a two-cord connector that plugs into a telephone wall jack.) Try removing the splitter and connecting the printer directly to the telephone wall jack.

- If your telephone system is not using a standard dial tone, such as some private branch exchange (PBX) systems, this might cause the test to fail. This does not cause a problem sending or receiving faxes. Try sending or receiving a test fax.
- Check to make sure the country/region setting is set appropriately for your country/region. If the country/region setting is not set or is set incorrectly, the test might fail and you might have problems sending and receiving faxes.
- Make sure you connect the printer to an analog phone line or you cannot send or receive faxes. To check if your phone line is digital, connect a regular analog phone to the line and listen for a dial tone. If you do not hear a normal sounding dial tone, it might be a phone line set up for digital phones. Connect the printer to an analog phone line and try sending or receiving a fax.

After you resolve any problems found, run the fax test again to make sure it passes and the printer is ready for faxing. If the **Dial Tone Detection** test continues to fail, contact your telephone company and have them check the phone line.

The "Fax Line Condition" test failed

- Make sure you connect the printer to an analog phone line or you cannot send or receive faxes. To check if your phone line is digital, connect a regular analog phone to the line and listen for a dial tone. If you do not hear a normal sounding dial tone, it might be a phone line set up for digital phones. Connect the printer to an analog phone line and try sending or receiving a fax.
- Check the connection between the telephone wall jack and the printer to make sure the phone cord is secure.
- Connect one end of the phone cord to your telephone wall jack, then connect the other end to the Fax port  on the back of the printer.
- Other equipment, which uses the same phone line as the printer, might be causing the test to fail. To find out if other equipment is causing a problem, disconnect everything from the phone line, and then run the test again.
 - If the **Fax Line Condition Test** passes without the other equipment, then one or more pieces of the equipment is causing problems; try adding them back one at a time and rerunning the test each time, until you identify which piece of equipment is causing the problem.
 - If the **Fax Line Condition Test** fails without the other equipment, connect the printer to a working phone line and continue reviewing the troubleshooting information in this section.
- If you are using a phone splitter, this can cause faxing problems. (A splitter is a two-cord connector that plugs into a telephone wall jack.) Try removing the splitter and connecting the printer directly to the telephone wall jack.

After you resolve any problems found, run the fax test again to make sure it passes and the printer is ready for faxing. If the **Fax Line Condition** test continues to fail and you experience problems faxing, contact your telephone company and have them check the phone line.

Troubleshoot fax problems



What kind of fax problem are you having?

The display always shows Phone Off Hook

- HP recommends using a 2-wire phone cord.

- Other equipment that uses the same phone line as the printer might be in use. Make sure extension phones (phones on the same phone line, but not connected to the printer) or other equipment are not in use or off the hook. For example, you cannot use the printer for faxing if an extension phone is off the hook, or if you are using a computer dial-up modem to send email or access the Internet.

The printer is having problems sending and receiving faxes

- Make sure the printer is turned on. Look at the display on the printer. If the display is blank and the Power button  light is not lit, the printer is turned off. Make sure the power cord is firmly connected to the printer and plugged into a power outlet. Press the Power button  to turn on the printer.

After turning on the printer, HP recommends you wait five minutes before sending or receiving a fax. The printer cannot send or receive faxes while it is initializing after being turned on.

- If HP Digital Fax has been enabled, you might not be able to send or receive faxes if the fax memory is full (limited by printer memory).
- Make sure one end of the phone cord is connected to the Fax port  on the back of the printer and the other end to your telephone wall jack.

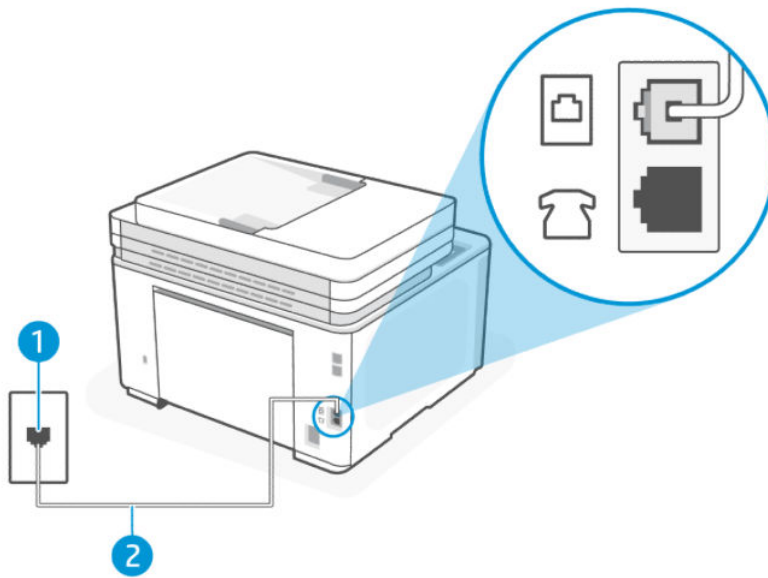



Table 9-16 Back view of the printer

Feature	Description
1	Telephone wall jack.
2	Use a minimum 26 AWG phone cord to connect to the Fax port  on the printer.

- Try connecting a working phone and phone cord to the telephone wall jack that you are using for the printer and check for a dial tone. If you do not hear a dial tone, call your local telephone company for service.

- Other equipment, which uses the same phone line as the printer, might be in use. For example, you cannot use the printer for faxing if an extension phone is off the hook, or if you are using a computer dial-up modem to send an email or access the Internet.
- Check to see if another process has caused an error. Check the display or your computer for an error message providing information about the problem and how to solve it. If there is an error, the printer cannot send or receive a fax until the error condition is resolved.
- The phone line connection might be noisy. Phone lines with poor sound quality (noise) can cause faxing problems. Check the sound quality of the phone line by plugging a phone into the telephone wall jack and listening for static or other noise. If you hear noise, turn **Error Correction Mode (ECM)** off and try faxing again. If the problem persists, contact your telephone company.
- If you are using a digital subscriber line (DSL) service, make sure that you have a DSL filter connected or you cannot fax successfully.
- Make sure the printer is not connected to a telephone wall jack that is set up for digital phones. To check if your phone line is digital, connect a regular analog phone to the line and listen for a dial tone. If you do not hear a normal sounding dial tone, it might be a phone line set up for digital phones.
- If you are using either a private branch exchange (PBX) or an integrated services digital network (ISDN) converter/terminal adaptor, make sure the printer is connected to the correct port and the terminal adaptor is set to the correct switch type for your country/region, if possible.
- If the printer shares the same phone line with a DSL service, the DSL modem might not be grounded correctly. If the DSL modem is not grounded correctly, it can create noise on the phone line. Phone lines with poor sound quality (noise) can cause faxing problems. You can check the sound quality of the phone line by plugging a phone into the telephone wall jack and listening for static or other noise. If you hear noise, turn off your DSL modem and completely remove power for at least 15 minutes. Turn the DSL modem back on and listen to the dial tone again.



NOTE: You might notice static on the phone line again in the future. If the printer stops sending and receiving faxes, repeat this process.

If the phone line is still noisy, contact your telephone company. For information on turning your DSL modem off, contact your DSL provider for support.

- If you are using a phone splitter, this can cause faxing problems. (A splitter is a two-cord connector that plugs into a telephone wall jack.) Try removing the splitter and connecting the printer directly to the telephone wall jack.

The printer cannot receive faxes, but can send faxes

- If you are not using a distinctive ring service, check to make sure that the **Distinctive Ring** feature on the printer is set to **All Standard Rings**.
- If **Auto Answer** is set to **Off**, you need to receive faxes manually; otherwise, the printer cannot receive the fax.
- If you have a voice mail service at the same phone number you use for fax calls, you must receive faxes manually, not automatically. This means that you must be available to respond in person to incoming fax calls.
- If you have a computer dial-up modem on the same phone line with the printer, check to make sure that the software that came with your modem is not set to receive faxes automatically. Modems that are set up to receive faxes automatically take over the phone line to receive all incoming faxes, which prevents the printer from receiving fax calls.

- If you have an answering machine on the same phone line with the printer, you might have one of the following problems:
 - Your answering machine might not be set up correctly with the printer.
 - Your outgoing message might be too long or too loud to allow the printer to detect fax tones, and the sending fax machine might disconnect.
 - Your answering machine might not have enough quiet time after your outgoing message to allow the printer to detect fax tones. This problem is most common with digital answering machines.

The following actions might help to solve these problems:

- When you have an answering machine on the same phone line you use for fax calls, try connecting the answering machine directly to the printer.
- Make sure the printer is set to receive faxes automatically.
- Make sure the **Rings to Answer** setting is set to a greater number of rings than the answering machine.
- Disconnect the answering machine and then try receiving a fax. If faxing is successful without the answering machine, the answering machine might be causing the problem.
- Reconnect the answering machine and record your outgoing message again. Record a message that is approximately 10 seconds in duration. Speak slowly and at a low volume when recording your message. Leave at least 5 seconds of silence at the end of the voice message. There should be no background noise when recording this silent time. Try to receive a fax again.



NOTE: Some digital answering machines might not retain the recorded silence at the end of your outgoing message. Play back your outgoing message to check.

- If the printer shares the same phone line with other types of phone equipment, such as an answering machine, a computer dial-up modem, or a multi-port switch box, the fax signal level might be reduced. The signal level can also be reduced if you use a splitter or connect extra cables to extend the length of your phone. A reduced fax signal can cause problems during fax reception.

To find out if other equipment is causing a problem, disconnect everything except the printer from the phone line, and then try to receive a fax. If you can receive faxes successfully without the other equipment, one or more pieces of the other equipment is causing problems; try adding them back one at a time and receiving a fax each time, until you identify which equipment is causing the problem.

- If you have a special ring pattern for your fax phone number (using a distinctive ring service through your telephone company), make sure that the **Distinctive Ring** feature on the printer is set to match.

The printer cannot send faxes, but can receive faxes

- The printer might be dialing too fast or too soon. You might need to insert some pauses in the number sequence. For example, if you need to access an outside line before dialing the phone number, insert a pause following the access number. If your number is 95555555, and 9 accesses an outside line, you might insert pauses as follows: 9-555-5555. To enter a pause in the fax number you are typing, touch the ***** repeatedly, until a dash (-) appears on the display.

You can also send the fax using monitor dialing. This enables you to listen to the phone line as you dial. You can set the pace of your dialing and respond to prompts as you dial.

- The number you entered when sending the fax is not in the proper format or the receiving fax machine is having problems. To check this, try calling the fax number from a telephone and listen for fax tones. If you cannot hear fax tones, the receiving fax machine might not be turned on or connected, or a voice mail service could be interfering with the recipient's phone line. You can also ask the recipient to check the receiving fax machine for any problems.

Fax tones are recorded on my answering machine

- When you have an answering machine on the same phone line you use for fax calls, try connecting the answering machine directly to the printer. If you do not connect the answering machine as recommended, fax tones might be recorded on your answering machine.
- Make sure the printer is set to receive faxes automatically and that the **Rings to Answer** setting is correct. The number of rings to answer for the printer should be greater than the number of rings to answer for the answering machine. If the answering machine and the printer are set to the same number of rings to answer, both devices answer the call and fax tones are recorded on the answering machine.
- Set your answering machine to a low number of rings and the printer to answer in the maximum number of rings supported. (The maximum number of rings varies by country/region.) In this setup, the answering machine answers the call and the printer monitors the line. If the printer detects fax tones, the printer receives the fax. If the call is a voice call, the answering machine records the incoming message.

The computer cannot receive faxes (HP Digital Fax)

- The computer selected to receive faxes is turned off. Make sure the computer selected to receive faxes is switched on at all times.
- Different computers are configured for setup and receiving faxes and one of them may be switched off. If the computer receiving faxes is different from the one used for setup, both computers should be switched on at all times.
- HP Digital Fax is not activated or the computer is not configured to receive faxes. Activate HP Digital Fax and make sure the computer is configured to receive faxes.

Solve wireless network problems

This topic describes how to troubleshoot wireless network issues.

Introduction

Use the troubleshooting information to help resolve issues.



NOTE: To determine if Wi-Fi Direct printing is enabled on your printer, print an information report from the printer control panel.

Wireless connectivity checklist

- Verify that the printer and the wireless router are turned on and have power. Also make sure that the wireless radio in the printer is turned on.
- Verify that the service set identifier (SSID) is correct. Print the network configuration page to determine the SSID. See [Print printer reports](#).
If you are not sure the SSID is correct, run the wireless setup again.

- With secured networks, verify that the security information is correct. If the security information is incorrect, run the wireless setup again.
- If the wireless network is working correctly, try accessing other computers on the wireless network. If the network has Internet access, try connecting to the Internet over a wireless connection.
- Verify that the encryption method (AES or TKIP) is the same for the printer as it is for the wireless access point (on networks using WPA security).
- Verify that the printer is within the range of the wireless network. For most networks, the printer must be within 30 m (100 ft) of the wireless access point (wireless router).
- Verify that obstacles do not block the wireless signal. Remove any large metal objects between the access point and the printer. Make sure poles, walls, or support columns containing metal or concrete do not separate the printer and wireless access point.
- Verify that the printer is located away from electronic devices that might interfere with the wireless signal. Many devices can interfere with the wireless signal including motors, cordless phones, security system cameras, other wireless networks, and some Bluetooth devices.
- Verify that the print driver is installed on the computer.
- Verify that you have selected the correct printer port.
- Verify that the computer and printer connect to the same wireless network.
- For OS X, verify that the wireless router supports Bonjour.

The printer does not print after the wireless configuration completes

1. Make sure that the printer is turned on and in the ready state.
2. Turn off any third-party firewalls on your computer.
3. Make sure that the wireless network is working correctly.
4. Make sure that your computer is working correctly. If necessary, restart the computer.
5. Verify that you can open the printer EWS from a computer on the network.

The printer does not print, and the computer has a third-party firewall installed

1. Update the firewall with the most recent update available from the manufacturer.
2. If programs request firewall access when you install the printer or try to print, make sure you allow the programs to run.
3. Temporarily turn off the firewall, and then install the wireless printer on the computer. Enable the firewall when you have completed the wireless installation.

The wireless connection does not work after moving the wireless router or printer

1. Make sure that the router or printer connects to the same network that your computer connects to.
2. Print a network configuration page.
3. Compare the service set identifier (SSID) on the information report to the SSID in the printer configuration for the computer.

4. If the numbers are not the same, the devices are not connecting to the same network. Reconfigure the wireless setup for the printer.

Cannot connect more devices to the wireless printer (Wi-Fi Direct)

1. Make sure that the other computers are within the wireless range and that no obstacles block the signal. For most networks, the wireless range is within 30 m (100 ft) of the wireless access point.
2. Make sure that the printer is turned on and in the ready state.
3. Make sure there are not more than 5 concurrent Wi-Fi Direct users.
4. Turn off any third-party firewalls on your computer.
5. Make sure that the wireless network is working correctly.
6. Make sure that your computer is working correctly. If necessary, restart the computer.

The printer cannot print when your computer is on a VPN

- The printer might lose connection when your computer switches to a virtual private network (VPN).

The network does not appear in the wireless networks list

- Make sure the wireless router is turned on and has power.
- The network might be hidden.
- Make sure that the printer is within wireless range of the wireless router, and that there are no obstacles blocking the signal.
- The printer operates on the 2.4 GHz and 5 GHz wireless bands.
- Refresh the wireless networks list.
- Try restarting the printer.

The wireless network is not functioning



1. To verify if the network has lost communication, try connecting other devices to the network.
2. Test network communication by pinging the network.
 - a. Open a command-line prompt on your computer.
 - For Windows, click **Start**, click **Run**, type `cmd`, and then press **Enter**.
 - For OS X, go to **Applications**, then **Utilities**, and open **Terminal**.
 - b. Type `ping` followed by the router IP address.
 - c. If the window displays round-trip times, the network is working.
3. Make sure that the router or printer connects to the same network that the computer connects to.
 - a. Print the network configuration page. See [Print printer reports](#).
 - b. Compare the service set identifier (SSID) on the information report to the SSID in the printer information for the computer.

- c. If the numbers are not the same, the devices are not connecting to the same network. Reconfigure the wireless setup for the printer.

Perform a wireless network diagnostic test

A wireless network diagnostic test can be performed using the printer control panel or the Embedded Web Server (EWS). The wireless network diagnostic test provides information about the wireless network settings.

Method one: Perform a wireless network diagnostic test using the printer control panel

1. From the printer control panel, touch or swipe down the tab  at the top of the screen to open the Dashboard, touch **Setup** .
2. Touch **Reports**.
3. Select **Wireless Test Report** to print.

Method two: Perform wireless network diagnostic test using the EWS

1. Open the EWS. See [Configure the printer using the Embedded Web Server \(EWS\)](#).
2. Select the **Tools** tab.
3. From the left menu, click **Reports** and select **Printer Reports**.
4. Click **Print Network Configuration Page** to test network connectivity problems.

Reduce interference on a wireless network

The following tips can reduce interference in a wireless network:

- Keep the wireless devices away from large metal objects, such as filing cabinets, and other electromagnetic devices, such as microwaves and cordless telephones. These objects can disrupt radio signals.
- Keep the wireless devices away from large masonry structures and other building structures. These objects can absorb radio waves and lower signal strength.
- Position the wireless router in a central location in line of sight with the wireless printers on the network.

Solve Ethernet connection problems

Check the following:

- The network is operational, and the network hub, switch, or router is turned on.
- The Ethernet cable is properly connected between the printer and the router. The Ethernet cable is plugged into the Ethernet port on the printer and the light near the connector lights up when connected.
- Antivirus programs, including spyware protection programs, are not impacting your network connection to the printer. If you know that antivirus or firewall software is preventing your computer from connecting to the printer, use the [HP online firewall troubleshooter](#) to help solve the problem.
- Run the [HP Print and Scan Doctor](#) to troubleshoot the issue automatically. The utility will try to diagnose and fix the issue. The HP Print and Scan Doctor may not be available in all languages.

A Printer specifications

The information contained herein is subject to change without notice.

Some statements might not be applicable for your printer or all countries/regions. For current information, visit hp.com/support. Select your country/region and language, find your printer, click **Product Information**, and check the product specifications for your printer.

Technical specifications

For more information, visit hp.com/support, select your country/region and language, find your printer, click **Product Information**, and then select Product specifications.

System requirements

For information about software and system requirements or future operating system releases and support, visit hp.com/support and find your printer.

Wi-Fi band supported

The supported Wi-Fi bands are Ethernet, Wi-Fi Direct®, and Dual band Wireless (802.11b/g/n) with Bluetooth.

Printer dimensions

This topic describes the printer dimensions.

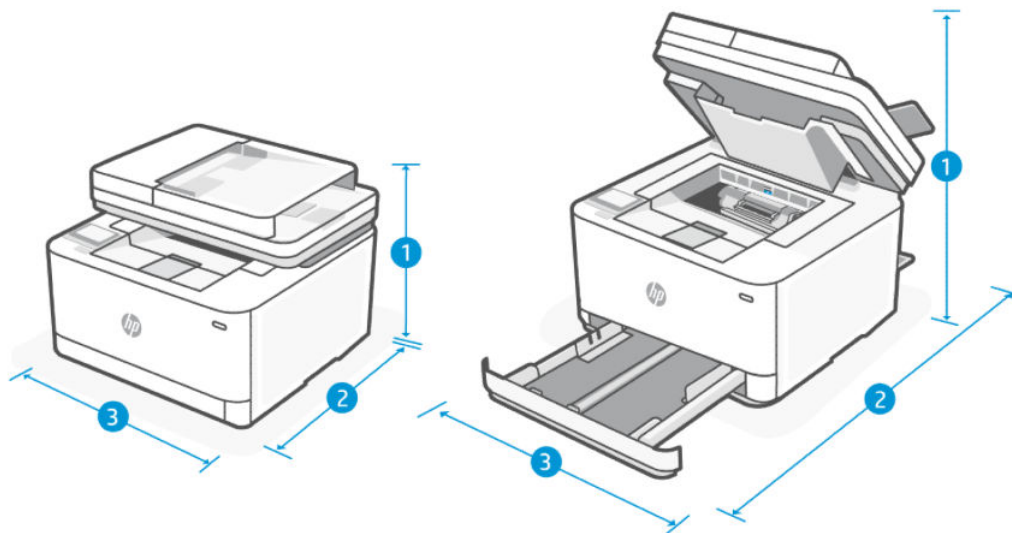

Table A-1 Printer dimensions

Dimensions	Printer fully closed	Printer fully open
1. Height	313.2 mm (12.33 in)	475.5 mm (18.72 in)

Table A-1 Printer dimensions (continued)

Dimensions	Printer fully closed	Printer fully open
2. Depth	398.2 mm (15.68 in)	758.8 mm (29.87 in)
3. Width	418 mm (16.46 in)	426.8 mm (16.80 in)
Weight (with cartridges)	10.5 kg (23.1 lb)	10.5 kg (23.1 lb)

Power consumption, electrical specifications, and acoustic emissions

For current information, visit hp.com/support and find your printer.

⚠ CAUTION: Power requirements are based on the country/region where the printer is sold. Do not convert operating voltages. This will damage the printer and void the printer warranty.

Operating-environment range

Table A-2 Operating-environment range

Environment	Recommended	Allowed
Temperature	17.5° to 25°C (63.5° to 77°F)	15° to 32.5°C (59° to 90.5°F)
Operating humidity	30% to 70% relative humidity (RH), non-condensing	10% to 80% (RH), non-condensing
Relative humidity	20% to 70% relative humidity (RH), non-condensing	10% to 80% (RH), non-condensing

Warning icons

Warning icon definitions: The following warning icons may appear on HP products. Apply appropriate caution where applicable.



Caution: Electric shock



Caution: Hot surface

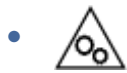

Caution: Keep body parts away from moving parts



Caution: Sharp edge in close proximity



Warning

Laser Warning



CAUTION - CLASS 3B INVISIBLE LASER RADIATION WHEN OPEN. AVOID EXPOSURE TO THE BEAM.

ATTENTION - RAYONNEMENT LASER INVISIBLE DE CLASSE 3B EN CAS D'OUVERTURE. ÉVITEZ L'EXPOSITION AU FAISCEAU.

VORSICHT - UNSICHTBARE LASERSTRAHLUNG KLASSE 3B, WENN ABDECKUNG GEÖFFNET. NICHT DEM STRAHL AUSSETZEN.

PRECAUCIÓN - RADIACIÓN LÁSER INVISIBLE DE CLASE 3B PRESENTE AL ABRIR. EVITE LA EXPOSICIÓN AL HAZ.

VARNING - OSYNLIG LASERSTRÅLNING KLASSE 3B VID ÖPPEN LUCKA UNDVIK EXPONERING FÖR LASERSTRÅLNINGEN.

VAROITUS - LUOKAN 3B NÄKYMÄTTÖMÄLLE LASER-SÄTEILYÄ AVATTUNA. VÄLTÄ ALTISTUMISTA SÄTEELLE.

注意 - 打开时，存在不可见的 3B 类激光辐射，请避免接触该激光束。

주의 - 커피엔 홀은 3B 비가시레이저 방사선이 발생할 수 있습니다. 광선에 노출을 피하십시오.

注意 - ここを開くとクラス 3B 不可視レーザー放射が出ます。ビームに身をさらさないこと。

B Service and support

This section describes the service and support information.

HP limited warranty statement

Table B-1 HP limited warranty statement

HP PRODUCT	DURATION OF LIMITED WARRANTY*
HP LaserJet Pro MFP 3101-3108 series	One-year limited warranty



NOTE: *Warranty and support options vary by product, country, and local legal requirements. Go to www.support.hp.com to learn about HP award-winning service and support options in your region. For details on the HP limited warranty policy on supplies, go to www.hp.com/go/learnaboutsupplies.

HP warrants to you, the end-user customer, this HP Limited Warranty applies only to HP branded products sold or leased a) from HP Inc., its subsidiaries, affiliates, authorized resellers, authorized distributors, or country distributors; and, b) with this HP Limited Warranty, that HP hardware and accessories will be free from defects in materials and workmanship after the date of purchase, for the period specified above. If HP receives notice of such defects during the warranty period, HP will, at its option, either repair or replace products which prove to be defective. Replacement products may be either new or equivalent in performance to new. HP products presented for repair may be replaced by refurbished goods of the same type rather than being repaired. Refurbished parts may be used to repair the goods. Repair of goods may result in lost user-generated data.

HP warrants to you that HP software will not fail to execute its programming instructions after the date of purchase, for the period specified above, due to defects in material and workmanship when properly installed and used. If HP receives notice of such defects during the warranty period, HP will replace software which does not execute its programming instructions due to such defects.

HP does not warrant that the operation of HP products will be uninterrupted or error free. If HP is unable, within a reasonable time, to repair or replace any product to a condition as warranted, you will be entitled to a refund of the purchase price upon prompt return of the product.

HP products may contain remanufactured parts equivalent to new in performance or may have been subject to incidental use.

Warranty does not apply to defects resulting from (a) improper or inadequate maintenance or calibration, (b) software, interfacing, parts or supplies not supplied by HP, (c) unauthorized modification or misuse, (d) operation outside of the published environmental specifications for the product, or (e) improper site preparation or maintenance.

TO THE EXTENT ALLOWED BY LOCAL LAW, THE ABOVE WARRANTIES ARE EXCLUSIVE AND NO OTHER WARRANTY OR CONDITION, WHETHER WRITTEN OR ORAL, IS EXPRESSED OR IMPLIED AND HP SPECIFICALLY DISCLAIMS ANY IMPLIED WARRANTIES OR CONDITIONS OF MERCHANTABILITY, SATISFACTORY QUALITY, AND FITNESS FOR A PARTICULAR PURPOSE. Some countries/regions, states or provinces do not allow limitations on the duration of an implied warranty, so the above limitation or exclusion might not apply to you. This warranty gives you specific legal rights and you might also have other rights that vary from country/region to country/region, state to state, or province to province. Please refer to the Country Specific statements at the end of this document.

HP's limited warranty is valid in any country/region or locality where HP has a support presence for this product and where HP has marketed this product. The level of warranty service you receive may vary according to local standards. HP will not alter form, fit or function of the product to make it operate in a country/region for which it was never intended to function for legal or regulatory reasons.

TO THE EXTENT ALLOWED BY LOCAL LAW, THE REMEDIES IN THIS WARRANTY STATEMENT ARE YOUR SOLE AND EXCLUSIVE REMEDIES. EXCEPT AS INDICATED ABOVE, IN NO EVENT WILL HP OR ITS SUPPLIERS BE LIABLE FOR LOSS OF DATA OR FOR DIRECT, SPECIAL, INCIDENTAL, CONSEQUENTIAL (INCLUDING LOST PROFIT OR DATA), OR OTHER DAMAGE, WHETHER BASED IN CONTRACT, TORT, OR OTHERWISE. Some countries/regions, states or provinces do not allow the exclusion or limitation of incidental or consequential damages, so the above limitation or exclusion may not apply to you.

THE WARRANTY TERMS CONTAINED IN THIS STATEMENT, EXCEPT TO THE EXTENT LAWFULLY PERMITTED, DO NOT EXCLUDE, RESTRICT OR MODIFY AND ARE IN ADDITION TO THE MANDATORY STATUTORY RIGHTS APPLICABLE TO THE SALE OF THIS PRODUCT TO YOU. PLEASE REFER TO THE COUNTRY SPECIFIC STATEMENTS AT THE END OF THIS DOCUMENT (IF APPLICABLE) FOR FURTHER INFORMATION ON YOUR CONSUMER RIGHTS.

Country Specific Terms

In some jurisdictions, you may have other statutory rights. Please see below.

Australia

Your rights as an Australian consumer are different to those stated in the document above.

You should disregard any limitations or exclusions in the above document and refer to the information below.

1. When you buy a good from HP as a consumer, the goods come with guarantees that cannot be excluded under the Australian Consumer Law. You are entitled to a replacement or refund for a major failure and for compensation for any other reasonably foreseeable loss or damage. You are also entitled to have the goods repaired or replaced if the goods fail to be of acceptable quality and the failure does not amount to a major failure.
2. This means that there is no defined warranty period for HP goods supplied to Australian consumers.
3. Instead, the goods should, for example, be fit for the purposes for which they are commonly supplied for such a period as a reasonable consumer fully acquainted with the state and condition of the goods would expect. This period may vary depending on the product.
4. You should contact HP if you are concerned that one of HP's products fails to satisfy any of the guarantees listed below. HP will discuss with you the specific nature and circumstances of that good and whether the particular fault/issue falls within the scope of the statutory guarantees.

Nothing in HP's Limited Warranty excludes, restricts, or modifies any condition, warranty, guarantee, right or remedy you may have at law (including a consumer guarantee under the Australian Consumer Law) which cannot be lawfully excluded or limited.

The relevant guarantees are as follows:

1. **Quality** — goods supplied by HP must be of acceptable quality. The test for acceptable quality is whether a reasonable consumer, fully aware of the state and condition of the goods, would find them:
 - safe, durable, and free from defects;
 - acceptable in appearance and finish; and
 - fit for all the purposes for which goods of that kind are commonly supplied.

This must take into account the nature and price of the goods, and any statements on packaging or labeling.

2. **Disclosed Purpose** — goods or services supplied by HP that HP represents are reasonably fit for a purpose expressly disclosed by a consumer must be reasonably fit for that purpose.
3. **Description** — goods supplied by HP must match the description provided by HP.
4. **Sample** — goods supplied by HP must match any sample shown to you by HP.
5. **Title** — a consumer who purchases a good from HP must receive clear title to the good.
6. **Due care and skill** — services provided to you by HP must be provided with due care and skill.
7. **Express warranties** — HP will be legally required to comply with the express warranty that is set out in its terms and conditions.
8. **Reasonable time** — repair services provided by HP must be provided within a reasonable time.

If you think that you are entitled to any of the above remedies or any remedy under the HP Worldwide Limited Warranty and Technical Support Document, please contact HP:

HP PPS Australia Pty Ltd

Rhodes Corporate Park, Building F, Level 5

1 Homebush Bay Drive

Rhodes, NSW 2138

Australia

To initiate a support request, please use the numbers below or visit www.hp.com.au and select the “Customer Service” option for the most current list of phone support numbers.

Product	Phone
Support for all HP Products except those listed separately below	13 10 47 If dialing internationally: +61 2 8278-1039
DeskJet, Office Jet, PSC, All-in-One, Photosmart & Personal LaserJet Series 1000, P1000, M1000 and Colour LaserJet CP1000 Series and model CM1415	1300 721 147 If dialing internationally: +61 2 8934 4380

For further information on consumer rights, visit www.consumerlaw.gov.au and www.accc.gov.au/consumerquarantees.

New Zealand

In New Zealand, the hardware and software come with guarantees that cannot be excluded under the New Zealand consumer law. In New Zealand, Consumer Transaction means a transaction involving a person who is purchasing goods for personal, domestic, or household use or consumption and not for the purpose of a business. New Zealand consumers who are purchasing goods for personal, domestic or household use or consumption and not for the purpose of a business (“New Zealand Consumers”) are entitled to repair, replacement or refund for a failure and compensation for other reasonably foreseeable loss or damage. A New Zealand Consumer (as defined above) may recover the costs of returning the product to the place of purchase if there is a breach of the New Zealand consumer law; furthermore, if it will be of significant cost to the New Zealand Consumer to return the goods to HP then HP will collect such goods at its own cost.

Table B-2 Support phone numbers

Product	Phone
Support for all HP Products except those listed separately below	0800 449 553 If dialing internationally: +61 2 8031-8317
DeskJet, Office Jet, PSC, All-in-One, Photosmart & Personal LaserJet Series 1000, P1000, M1000 and Colour LaserJet CP1000 Series and model CM1415	0800 441 147 If dialing internationally: +61 2 8934 4380

UK, Ireland, and Malta

The HP Limited Warranty is a commercial guarantee voluntarily provided by HP. The name and address of the HP entity responsible for the performance of the HP Limited Warranty in your country/region is as follows:

UK: HP Inc UK Limited, Cain Road, Amen Corner, Bracknell, Berkshire, RG12 1HN

Ireland: Hewlett-Packard Ireland Limited, Liffey Park Technology Campus, Barnhall Road, Leixlip, Co.Kildare

Malta: Hewlett-Packard Europe B.V., Amsterdam, Meyrin Branch, Route du Nant-d'Avril 150, 1217 Meyrin, Switzerland

United Kingdom: The HP Limited Warranty benefits apply in addition to any legal rights to a guarantee from seller of nonconformity of goods with the contract of sale. These rights expire six years from delivery of goods for products purchased in England or Wales and five years from delivery of goods for products purchased in Scotland. However various factors may impact your eligibility to receive these rights. For further information, please consult the following link: Consumer Legal Guarantee (www.hp.com/go/eu-legal) or you may visit the European Consumer Centers website (ec.europa.eu/consumers/solving_consumer_disputes/nonjudicial_redress/ecc-net/index_en.htm). Consumers have the right to choose whether to claim service under the HP Limited Warranty or against the seller under the legal guarantee.

Ireland: The HP Limited Warranty benefits apply in addition to any statutory rights from seller in relation to nonconformity of goods with the contract of sale. However various factors may impact your eligibility to receive these rights. Consumer statutory rights are not limited or affected in any manner by HP Care Pack. For further information, please consult the following link: Consumer Legal Guarantee (www.hp.com/go/eu-legal) or you may visit the European Consumer Centers website (ec.europa.eu/consumers/solving_consumer_disputes/nonjudicial_redress/ecc-net/index_en.htm). Consumers have the right to choose whether to claim service under the HP Limited Warranty or against the seller under the legal guarantee.

Malta: The HP Limited Warranty benefits apply in addition to any legal rights to a two-year guarantee from seller of nonconformity of goods with the contract of sale; however various factors may impact your eligibility to receive these rights. Consumer statutory rights are not limited or affected in any manner by the HP Limited Warranty. For further information, please consult the following link: Consumer Legal Guarantee (www.hp.com/go/eu-legal) or you may visit the European Consumer Centers website (ec.europa.eu/consumers/solving_consumer_disputes/nonjudicial_redress/ecc-net/index_en.htm). Consumers have the right to choose whether to claim service under the HP Limited Warranty or against the seller under two-year legal guarantee.

Austria, Belgium, Germany, and Luxemburg

Die beschränkte HP Herstellergarantie ist eine von HP auf freiwilliger Basis angebotene kommerzielle Garantie. Der Name und die Adresse der HP Gesellschaft, die in Ihrem Land für die Gewährung der beschränkten HP Herstellergarantie verantwortlich ist, sind wie folgt:

Deutschland: HP Deutschland GmbH, Schickardstr. 32, D-71034 Böblingen

Österreich: HP Austria GmbH., Technologiestrasse 5, A-1120 Wien

Luxemburg: Hewlett-Packard Luxembourg S.C.A., 75, Parc d'Activités Capellen, Rue Pafebruc, L-8308 Capellen

Belgien: HP Belgium BVBA, Hermeslaan 1A, B-1831 Diegem

Die Rechte aus der beschränkten HP Herstellergarantie gelten zusätzlich zu den gesetzlichen Ansprüchen wegen Sachmängeln auf eine zweijährige Gewährleistung ab dem Lieferdatum. Ob Sie Anspruch auf diese Rechte haben, hängt von zahlreichen Faktoren ab. Die Rechte des Kunden sind in keiner Weise durch die beschränkte HP Herstellergarantie eingeschränkt bzw. betroffen. Weitere Hinweise finden Sie auf der folgenden Website: Gewährleistungsansprüche für Verbraucher (www.hp.com/go/eu-legal) oder Sie können die Website des Europäischen Verbraucherzentrums (ec.europa.eu/consumers/solving_consumer_disputes/nonjudicial_redress/ecc-net/index_en.htm) besuchen. Verbraucher haben das Recht zu wählen, ob sie eine Leistung von HP gemäß der beschränkten HP Herstellergarantie in Anspruch nehmen oder ob sie sich gemäß der gesetzlichen zweijährigen Haftung für Sachmängel (Gewährleistung) sich an den jeweiligen Verkäufer wenden.

Belgium, France, and Luxembourg

La garantie limitée HP est une garantie commerciale fournie volontairement par HP. Voici les coordonnées de l'entité HP responsable de l'exécution de la garantie limitée HP dans votre pays:

France: HP France SAS, société par actions simplifiée identifiée sous le numéro 448 694 133 RCS Evry, 1 Avenue du Canada, 91947, Les Ulis

G.D. Luxembourg: Hewlett-Packard Luxembourg S.C.A., 75, Parc d'Activités Capellen, Rue Pafebruc, L-8308 Capellen

Belgique: HP Belgium BVBA, Hermeslaan 1A, B-1831 Diegem

France: Les avantages de la garantie limitée HP s'appliquent en complément des droits dont vous disposez au titre des garanties légales applicables dont le bénéfice est soumis à des conditions spécifiques. Vos droits en tant que consommateur au titre de la garantie légale de conformité mentionnée aux articles L. 211-4 à L. 211-13 du Code de la Consommation et de celle relatives aux défauts de la chose vendue, dans les conditions prévues aux articles 1641 à 1648 et 2232 du Code de Commerce ne sont en aucune façon limités ou affectés par la garantie limitée HP. Pour de plus amples informations, veuillez consulter le lien suivant : Garanties légales accordées au consommateur (www.hp.com/go/eu-legal). Vous pouvez également consulter le site Web des Centres européens des consommateurs (ec.europa.eu/consumers/solving_consumer_disputes/nonjudicial_redress/ecc-net/index_en.htm). Les consommateurs ont le droit de choisir d'exercer leurs droits au titre de la garantie limitée HP, ou auprès du vendeur au titre des garanties légales applicables mentionnées ci-dessus.

POUR RAPPEL:

Garantie Légale de Conformité:

« Le vendeur est tenu de livrer un bien conforme au contrat et répond des défauts de conformité existant lors de la délivrance.

Il répond également des défauts de conformité résultant de l'emballage, des instructions de montage ou de l'installation lorsque celle-ci a été mise à sa charge par le contrat ou a été réalisée sous sa responsabilité ».

Article L211-5 du Code de la Consommation:

« Pour être conforme au contrat, le bien doit:

1° Etre propre à l'usage habituellement attendu d'un bien semblable et, le cas échéant:

- correspondre à la description donnée par le vendeur et posséder les qualités que celui-ci a présentées à l'acheteur sous forme d'échantillon ou de modèle;

- présenter les qualités qu'un acheteur peut légitimement attendre eu égard aux déclarations publiques faites par le vendeur, par le producteur ou par son représentant, notamment dans la publicité ou l'étiquetage;

2° Ou présenter les caractéristiques définies d'un commun accord par les parties ou être propre à tout usage spécial recherché par l'acheteur, porté à la connaissance du vendeur et que ce dernier a accepté ».

Article L211-12 du Code de la Consommation:

« L'action résultant du défaut de conformité se prescrit par deux ans à compter de la délivrance du bien ».

Garantie des vices cachés

Article 1641 du Code Civil : « Le vendeur est tenu de la garantie à raison des défauts cachés de la chose vendue qui la rendent impropre à l'usage auquel on la destine, ou qui diminuent tellement cet usage que l'acheteur ne l'aurait pas acquise, ou n'en aurait donné qu'un moindre prix, s'il les avait connus. »

Article 1648 alinéa 1 du Code Civil:

« L'action résultant des vices rédhibitoires doit être intentée par l'acquéreur dans un délai de deux ans à compter de la découverte du vice. »

G.D. Luxembourg et Belgique: Les avantages de la garantie limitée HP s'appliquent en complément des droits dont vous disposez au titre de la garantie de non-conformité des biens avec le contrat de vente. Cependant, de nombreux facteurs peuvent avoir un impact sur le bénéfice de ces droits. Vos droits en tant que consommateur au titre de ces garanties ne sont en aucune façon limités ou affectés par la garantie limitée HP. Pour de plus amples informations, veuillez consulter le lien suivant : Garanties légales accordées au consommateur (www.hp.com/go/eu-legal) ou vous pouvez également consulter le site Web des Centres européens des consommateurs (ec.europa.eu/consumers/solving_consumer_disputes/nonjudicial_redress/ecc-net/index_en.htm). Les consommateurs ont le droit de choisir de réclamer un service sous la garantie limitée HP ou auprès du vendeur au cours d'une garantie légale de deux ans.

Italy

La Garanzia limitata HP è una garanzia commerciale fornita volontariamente da HP. Di seguito sono indicati nome e indirizzo della società HP responsabile della fornitura dei servizi coperti dalla Garanzia limitata HP nel vostro Paese:

Italia: HP Italy S.r.l., Via G. Di Vittorio 9, 20063 Cernusco S/Naviglio

I vantaggi della Garanzia limitata HP vengono concessi ai consumatori in aggiunta ai diritti derivanti dalla garanzia di due anni fornita dal venditore in caso di non conformità dei beni rispetto al contratto di vendita. Tuttavia, diversi fattori possono avere un impatto sulla possibilità di beneficiare di tali diritti. I diritti spettanti ai consumatori in forza della garanzia legale non sono in alcun modo limitati, né modificati dalla Garanzia limitata HP. Per ulteriori informazioni, si prega di consultare il seguente link: Garanzia legale per i clienti (www.hp.com/go/eu-legal), oppure visitare il sito Web dei Centri europei per i consumatori (ec.europa.eu/consumers/solving_consumer_disputes/nonjudicial_redress/ecc-net/index_en.htm). I consumatori hanno il diritto di scegliere se richiedere un servizio usufruendo della Garanzia limitata HP oppure rivolgendosi al venditore per far valere la garanzia legale di due anni.

Spain

Su Garantía limitada de HP es una garantía comercial voluntariamente proporcionada por HP. El nombre y dirección de las entidades HP que proporcionan la Garantía limitada de HP (garantía comercial adicional del fabricante) en su país es:

España: Hewlett-Packard Española S.L. Calle Vicente Aleixandre, 1 Parque Empresarial Madrid - Las Rozas, E-28232 Madrid

Los beneficios de la Garantía limitada de HP son adicionales a la garantía legal de 2 años a la que los consumidores tienen derecho a recibir del vendedor en virtud del contrato de compraventa; sin embargo, varios factores pueden afectar su derecho a recibir los beneficios bajo dicha garantía legal. A este respecto, la Garantía limitada de HP no limita o afecta en modo alguno los derechos legales del consumidor (www.hp.com/go/eu-legal). Para más información, consulte el siguiente enlace: Garantía legal del consumidor o puede visitar el sitio web de los Centros europeos de los consumidores (ec.europa.eu/consumers/solving_consumer_disputes/nonjudicial_redress/ecc-net/index_en.htm). Los clientes tienen derecho a elegir si reclaman un servicio acogiéndose a la Garantía limitada de HP o al vendedor de conformidad con la garantía legal de dos años.

Denmark

Den begrænsede HP-garanti er en garanti, der ydes frivilligt af HP. Navn og adresse på det HP-selskab, der er ansvarligt for HP's begrænsede garanti i dit land, er som følger:

Danmark: HP Inc Danmark ApS, Engholm Parkvej 8, 3450, Allerød

Den begrænsede HP-garanti gælder i tillæg til eventuelle juridiske rettigheder, for en toårig garanti fra sælgeren af varer, der ikke er i overensstemmelse med salgsaftalen, men forskellige faktorer kan dog påvirke din ret til at opnå disse rettigheder. Forbrugerens lovbestemte rettigheder begrænses eller påvirkes ikke på nogen måde af den begrænsede HP-garanti. Se nedenstående link for at få yderligere oplysninger: Forbrugerens juridiske garanti (www.hp.com/go/eu-legal) eller du kan besøge De Europæiske Forbrugercentres websted (ec.europa.eu/consumers/solving_consumer_disputes/nonjudicial_redress/ecc-net/index_en.htm). Forbrugere har ret til at vælge, om de vil gøre krav på service i henhold til HP's begrænsede garanti eller hos sælger i henhold til en toårig juridisk garanti.

Norway

HPs garanti er en begrenset og kommersiell garanti som HP selv har valgt å tilby. Følgende lokale selskap innestår for garantien:

Norge: HP Norge AS, Rolfbuktveien 4b, 1364 Fornebu

HPs garanti kommer i tillegg til det mangelsansvar HP har i henhold til norsk forbrukerkjøpslovgivning, hvor reklamasjonsperioden kan være to eller fem år, avhengig av hvor lenge salgsgjenstanden var ment å vare. Ulike faktorer kan imidlertid ha betydning for om du kvalifiserer til å kreve avhjelp iht slikt mangelsansvar. Forbrukerens lovmessige rettigheter begrenses ikke av HPs garanti. Hvis du vil ha mer informasjon, kan du klikke på følgende kobling: Juridisk garanti for forbruker (www.hp.com/go/eu-legal) eller du kan besøke nettstedet til de europeiske forbrukersentrene (ec.europa.eu/consumers/solving_consumer_disputes/nonjudicial_redress/ecc-net/index_en.htm). Forbrukere har retten til å velge å kreve service under HPs garanti eller iht selgerens lovpålagte mangelsansvar.

Sweden

HP:s begränsade garanti är en kommersiell garanti som tillhandahålls frivilligt av HP. Namn och adress till det HP-företag som ansvarar för HP:s begränsade garanti i ditt land är som följer:

Sverige: HP PPS Sverige AB, SE-169 73 Stockholm

Fördelarna som ingår i HP:s begränsade garanti gäller utöver de lagstadgade rättigheterna till tre års garanti från säljaren angående varans bristande överensstämmelse gentemot köpeavtalet, men olika faktorer kan påverka din rätt att utnyttja dessa rättigheter. Konsumentens lagstadgade rättigheter varken begränsas eller påverkas på något sätt av HP:s begränsade garanti. Mer information får du om du följer denna länk: Lagstadgad garanti för konsumenter (www.hp.com/go/eu-legal) eller så kan du gå till European Consumer Centers webbplats (ec.europa.eu/consumers/solving_consumer_disputes/nonjudicial_redress/ecc-net/index_en.htm). Konsumenter har rätt att välja om de vill ställa krav enligt HP:s begränsade garanti eller på säljaren enligt den lagstadgade treåriga garantin.

Portugal

A Garantia Limitada HP é uma garantia comercial fornecida voluntariamente pela HP. O nome e a morada da entidade HP responsável pela prestação da Garantia Limitada HP no seu país são os seguintes:

Portugal: HPCP – Computing and Printing Portugal, Unipessoal, Lda., Edifício D. Sancho I, Quinta da Fonte, Porto Salvo, Lisboa, Oeiras, 2740 244

As vantagens da Garantia Limitada HP aplicam-se cumulativamente com quaisquer direitos decorrentes da legislação aplicável à garantia de dois anos do vendedor, relativa a defeitos do produto e constante do contrato de venda. Existem, contudo, vários fatores que poderão afetar a sua elegibilidade para beneficiar de tais direitos. Os direitos legalmente atribuídos aos consumidores não são limitados ou afetados de forma alguma pela Garantia Limitada HP. Para mais informações, consulte a ligação seguinte: Garantia legal do consumidor (www.hp.com/go/eu-legal) ou visite o Web site da Rede dos Centros Europeus do Consumidor (ec.europa.eu/consumers/solving_consumer_disputes/nonjudicial_redress/ecc-net/index_en.htm). Os consumidores têm o direito de escolher se pretendem reclamar assistência ao abrigo da Garantia Limitada HP ou contra o vendedor ao abrigo de uma garantia jurídica de dois anos.

Greece and Cyprus

H Περιορισμένη εγγύηση HP είναι μια εμπορική εγγύηση η οποία παρέχεται εθελοντικά από την HP. Η επωνυμία και η διεύθυνση του νομικού προσώπου HP που παρέχει την Περιορισμένη εγγύηση HP στη χώρα σας είναι η εξής:

Ελλάδα /Κύπρος: HP Printing and Personal Systems Hellas EPE, Tzavella 1-3, 15232 Chalandri, Attiki

Ελλάδα /Κύπρος: HP Συστήματα Εκτύπωσης και Προσωπικών Υπολογιστών Ελλάς Εταιρεία Περιορισμένης Ευθύνης, Tzavella 1-3, 15232 Chalandri, Attiki

Τα προνόμια της Περιορισμένης εγγύησης HP ισχύουν επιπλέον των νόμιμων δικαιωμάτων για διετή εγγύηση έναντι του Πωλητή για τη μη συμμόρφωση των προϊόντων με τις συνομολογημένες συμβατικά ιδιότητες, ωστόσο η άσκηση των δικαιωμάτων σας αυτών μπορεί να εξαρτάται από διάφορους παράγοντες. Τα νόμιμα δικαιώματα των καταναλωτών δεν περιορίζονται ούτε επηρεάζονται καθ' οιονδήποτε τρόπο από την Περιορισμένη εγγύηση HP. Για περισσότερες πληροφορίες, συμβουλευτείτε την ακόλουθη τοποθεσία web: Νόμιμη εγγύηση καταναλωτή (www.hp.com/go/eu-legal) ή μπορείτε να επισκεφτείτε την τοποθεσία web των Ευρωπαϊκών Κέντρων Καταναλωτή (ec.europa.eu/consumers/solving_consumer_disputes/nonjudicial_redress/ecc-net/index_en.htm). Οι καταναλωτές έχουν το δικαίωμα να επιλέξουν αν θα αξιώσουν την υπηρεσία στα πλαίσια της Περιορισμένης εγγύησης HP ή από τον πωλητή στα πλαίσια της νόμιμης εγγύησης δύο ετών.

Hungary

A HP korlátozott jótállás egy olyan kereskedelmi jótállás, amelyet a HP a saját elhatározásából biztosít. Az egyes országokban a HP mint gyártó által vállalt korlátozott jótállást biztosító HP vállalatok neve és címe:

Magyarország: HP Inc Magyarország Kft., H-1117 Budapest, Alíz utca 1.

A HP korlátozott jótállásban biztosított jogok azokon a jogokon felül illetik meg Önt, amelyek a termékeknek az adásvételi szerződés szerinti minőségére vonatkozó kétéves, jogszabályban foglalt eladói szavatosságból, továbbá ha az Ön által vásárolt termékre alkalmazandó, a jogszabályban foglalt kötelező eladói jótállásból erednek, azonban számos körülmény hatással lehet arra, hogy ezek a jogok Önt megilletik-e. További információért kérjük, keresse fel a következő webhelyet: Jogi Tájékoztató Fogyasztóknak (www.hp.com/go/eu-legal) vagy látogassa meg az Európai Fogyasztói Központok webhelyét (ec.europa.eu/consumers/solving_consumer_disputes/nonjudicial_redress/ecc-net/index_en.htm). A fogyasztóknak jogában áll, hogy megválasszák, hogy a jótállással kapcsolatos igényüket a HP korlátozott jótállás alapján vagy a kétéves, jogszabályban foglalt eladói szavatosság, illetve, ha alkalmazandó, a jogszabályban foglalt kötelező eladói jótállás alapján érvényesítik.

Czech Republic

Omezená záruka HP je obchodní zárukou dobrovolně poskytovanou společností HP. Názvy a adresy společností skupiny HP, které odpovídají za plnění omezené záruky HP ve vaší zemi, jsou následující:

Česká republika: HP Inc Czech Republic s. r. o., Za Brumlovkou 5/1559, 140 00 Praha 4

Výhody, poskytované omezenou zárukou HP, se uplatňují jako doplněk k jakýmkoli právním nárokům na dvouletou záruku poskytnutou prodejcem v případě nesouladu zboží s kupní smlouvou. Váš nárok na uznání těchto práv však může záviset na mnohých faktorech. Omezená záruka HP žádným způsobem neomezuje ani neovlivňuje zákonná práva zákazníka. Další informace získáte kliknutím na následující odkaz: Zákonná záruka spotřebitele (www.hp.com/go/eu-legal) případně můžete navštívit webové stránky Evropského spotřebitelského centra (ec.europa.eu/consumers/solving_consumer_disputes/nonjudicial_redress/ecc-net/index_en.htm). Spotřebitelé mají právo se rozhodnout, zda chtějí službu reklamovat v rámci omezené záruky HP nebo v rámci zákonem stanovené dvouleté záruky u prodejce.

Slovakia

Obmedzená záruka HP je obchodná záruka, ktorú spoločnosť HP poskytuje dobrovoľne. Meno a adresa subjektu HP, ktorý zabezpečuje plnenie vyplývajúce z Obmedzenej záruky HP vo vašej krajine:

Slovenská republika: HP Inc Slovakia, s.r.o., Galvaniho 7, 821 04 Bratislava

Výhody Obmedzenej záruky HP sa uplatnia vedľa prípadných zákazníkovoých zákonných nárokov voči predávajúcemu z váš, ktoré spočívajú v nesúlade vlastností tovaru s jeho popisom podľa predmetnej zmluvy. Možnosť uplatnenia takých prípadných nárokov však môže závisieť od rôznych faktorov. Služby Obmedzenej záruky HP žiadnym spôsobom neobmedzujú ani neovplyvňujú zákonné práva zákazníka, ktorý je spotrebiteľom. Ďalšie informácie nájdete na nasledujúcom prepojení: Zákonná záruka spotrebiteľa (www.hp.com/go/eu-legal), prípadne môžete navštíviť webovú lokalitu európskych zákazníkovoých stredísk (ec.europa.eu/consumers/solving_consumer_disputes/nonjudicial_redress/ecc-net/index_en.htm). Spotrebiteľia majú právo zvoliť si, či chcú uplatniť servis v rámci Obmedzenej záruky HP alebo počas zákonnej dvojročnej záručnej lehoty u predajcu.

Poland

Ograniczona gwarancja HP to komercyjna gwarancja udzielona dobrowolnie przez HP. Nazwa i adres podmiotu HP odpowiedzialnego za realizację Ograniczonej gwarancji HP w Polsce:

Polska: HP Inc Polska sp. z o.o., Szturmowa 2a, 02-678 Warszawa, wpisana do rejestru przedsiębiorców prowadzonego przez Sąd Rejonowy dla m.st. Warszawy w Warszawie, XIII Wydział Gospodarczy Krajowego Rejestru Sądowego, pod numerem KRS 0000546115, NIP 5213690563, REGON 360916326, GIOŚ E0020757WZBW, kapitał zakładowy 480.000 PLN.

Świadczenia wynikające z Ograniczonej gwarancji HP stanowią dodatek do praw przysługujących nabywcy w związku z dwuletnią odpowiedzialnością sprzedawcy z tytułu niezgodności towaru z umową (rękojmią). Niemniej, na możliwość korzystania z tych praw mają wpływ różne czynniki. Ograniczona gwarancja HP w żaden sposób nie ogranicza praw konsumenta ani na nie nie wpływa. Więcej informacji można znaleźć pod następującym łączem: Gwarancja prawna konsumenta (www.hp.com/go/eu-legal), można także odwiedzić stronę internetową Europejskiego Centrum Konsumentckiego (ec.europa.eu/consumers/solving_consumer_disputes/nonjudicial_redress/ecc-net/index_en.htm). Konsumentci mają prawo wyboru co do możliwości skorzystania albo z usług gwarancyjnych przysługujących w ramach Ograniczonej gwarancji HP albo z uprawnień wynikających z dwuletniej rękojmi w stosunku do sprzedawcy.

Bulgaria

Ограничената гаранция на HP представлява търговска гаранция, доброволно предоставяна от HP. Името и адресът на дружеството на HP за вашата страна, отговорно за предоставянето на гаранционната поддръжка в рамките на Ограничената гаранция на HP, са както следва:

HP Inc Bulgaria EOOD (Ейч Пи Инк България EOOD), гр. София 1766, район р-н Младост, бул. Околовръстен Път No 258, Бизнес Център Камбаните

Предимствата на Ограничената гаранция на HP се прилагат в допълнение към всички законови права за двугодишна гаранция от продавача при несъответствие на стоката с договора за продажба. Въпреки това, различни фактори могат да окажат влияние върху условията за получаване на тези права. Законите права на потребителите не са ограничени или засегнати по никакъв начин от Ограничената гаранция на HP. За допълнителна информация, моля вижте Правната гаранция на потребителя (www.hp.com/go/eu-legal) или посетете уебсайта на Европейския потребителски център (ec.europa.eu/consumers/solving_consumer_disputes/nonjudicial_redress/ecc-net/index_en.htm). Потребителите имат правото да избират дали да претендират за извършване на услуга в рамките на Ограничената гаранция на HP или да потърсят такава от търговеца в рамките на двугодишната правна гаранция.

Romania

Гаранția limitată HP este o garanție comercială furnizată în mod voluntar de către HP. Numele și adresa entității HP răspunzătoare de punerea în aplicare a Garanției limitate HP în țara dumneavoastră sunt următoarele:

România: HP Inc Romania SRL, 5 Fabrica de Glucoza Str., Building F, Ground Floor and Floor 8, 2nd District, București

Beneficiile Garanției limitate HP se aplică suplimentar față de orice drepturi privind garanția de doi ani oferită de vânzător pentru neconformitatea bunurilor cu contractul de vânzare; cu toate acestea, diversi factori pot avea impact asupra eligibilității dvs. de a beneficia de aceste drepturi. Drepturile legale ale consumatorului nu sunt limitate sau afectate în vreun fel de Garanția limitată HP. Pentru informații suplimentare consultați următorul link: гаранцията acordată consumatorului prin lege (www.hp.com/go/eu-legal) sau puteți accesa site-ul Centrul European al Consumatorilor (ec.europa.eu/consumers/solving_consumer_disputes/nonjudicial_redress/ecc-net/index_en.htm). Consumatorii au dreptul să alegă dacă să pretendă despăгубири în cadrul Гаранției limitate HP sau de la vânзător, în cadrul гаранției legale de doi ani.

Belgium and the Netherlands

De Beperkte Garantie van HP is een commerciële garantie vrijwillig verstrekt door HP. De naam en het adres van de HP-entiteit die verantwoordelijk is voor het uitvoeren van de Beperkte Garantie van HP in uw land is als volgt:

Nederland: HP Nederland B.V., Startbaan 16, 1187 XR Amstelveen

België: HP Belgium BVBA, Hermeslaan 1A, B-1831 Diegem

De voordelen van de Beperkte Garantie van HP vormen een aanvulling op de wettelijke garantie voor consumenten gedurende twee jaren na de levering te verlenen door de verkoper bij een gebrek aan conformiteit van de goederen met de relevante verkoopovereenkomst. Niettemin kunnen diverse factoren een impact hebben op uw eventuele aanspraak op deze wettelijke rechten. De wettelijke rechten van de consument worden op geen enkele wijze beperkt of beïnvloed door de Beperkte Garantie van HP. Raadpleeg voor meer informatie de volgende webpagina: Wettelijke garantie van de consument (www.hp.com/go/eu-legal) of u kan de website van het Europees Consumenten Centrum bezoeken (ec.europa.eu/consumers/solving_consumer_disputes/nonjudicial_redress/ecc-net/index_en.htm). Consumenten hebben het recht om te kiezen tussen enerzijds de Beperkte Garantie van HP of anderzijds het aanspreken van de verkoper in toepassing van de wettelijke garantie.

Finland

HP:n rajoitettu takuu on HP:n vapaaehtoisesti antama kaupallinen takuu. HP:n myöntämästä takuusta maassanne vastaavan HP:n edustajan yhteystiedot ovat:

Suomi: HP Finland Oy, Piispankalliontie, FIN - 02200 Espoo

HP:n takuun edut ovat voimassa mahdollisten kuluttajansuojalakiin perustuvien oikeuksien lisäksi sen varalta, että tuote ei vastaa myyntisopimusta. Saat lisätietoja seuraavasta linkistä: Kuluttajansuoja (www.hp.com/go/eu-legal) tai voit käydä Euroopan kuluttajakeskuksen sivustolla (ec.europa.eu/consumers/solving_consumer_disputes/nonjudicial_redress/ecc-net/index_en.htm). Kuluttajilla on oikeus vaatia virheen korjausta HP:n takuun ja kuluttajansuojan perusteella HP:lta tai myyjältä.

Slovenia

Omejena garancija HP je prostovoljna trgovska garancija, ki jo zagotavlja podjetje HP. Ime in naslov poslovne enote HP, ki je odgovorna za omejeno garancijo HP v vaši državi, sta naslednja:

Slovenija: Hewlett-Packard Europe B.V., Amsterdam, Meyrin Branch, Route du Nant-d'Avril 150, 1217 Meyrin, Switzerland

Ugodnosti omejene garancije HP veljajo poleg zakonskih pravic, ki ob sklenitvi kupoprodajne pogodbe izhajajo iz dveletne garancije prodajalca v primeru neskladnosti blaga, vendar lahko na izpolnjevanje pogojev za uveljavitev pravic vplivajo različni dejavniki. Omejena garancija HP nikakor ne omejuje strankinih z zakonom predpisanih pravic in ne vpliva nanje. Za dodatne informacije glejte naslednjo povezavo: Strankino pravno jamstvo (www.hp.com/go/eu-legal); ali pa obiščite spletno mesto evropskih središč za potrošnike (ec.europa.eu/consumers/solving_consumer_disputes/nonjudicial_redress/ecc-net/index_en.htm). Potrošniki imajo pravico izbrati, ali bodo uveljavljali pravice do storitev v skladu z omejeno garancijo HP ali proti prodajalcu v skladu z dvoletno zakonsko garancijo.

Croatia

HP ograničeno jamstvo komercijalno je dobrovoljno jamstvo koje pruža HP. Ime i adresa HP subjekta odgovornog za HP ograničeno jamstvo u vašoj državi:

Hrvatska: HP Computing and Printing d.o.o. za računalne i srodne aktivnosti, Radnička cesta 41, 10000 Zagreb

Pogodnosti HP ograničenog jamstva vrijede zajedno uz sva zakonska prava na dvogodišnje jamstvo kod bilo kojeg prodavača s obzirom na nepodudaranje robe s ugovorom o kupnji. Međutim, razni faktori mogu utjecati na vašu mogućnost ostvarivanja tih prava. HP ograničeno jamstvo ni na koji način ne utječe niti ne ograničava zakonska prava potrošača. Dodatne informacije potražite na ovoj adresi: Zakonsko jamstvo za potrošače (www.hp.com/go/eu-legal) ili možete posjetiti web-mjesto Europskih potrošačkih centara (ec.europa.eu/consumers/solving_consumer_disputes/nonjudicial_redress/ecc-net/index_en.htm). Potrošači imaju pravo odabrati žele li ostvariti svoja potraživanja u sklopu HP ograničenog jamstva ili pravnog jamstva prodavača u trajanju ispod dvije godine.

Latvia

HP ierobežotā garantija ir komercgarantija, kuru brīvprātīgi nodrošina HP. HP uzņēmums, kas sniedz HP ierobežotās garantijas servisa nodrošinājumu jūsu valstī:

Latvija: HP Finland Oy, PO Box 515, 02201 Espoo, Finland

HP ierobežotās garantijas priekšrocības tiek piedāvātas papildus jebkurām likumīgajām tiesībām uz pārdevēja un/vai ražotāju nodrošinātu divu gadu garantiju gadījumā, ja preces neatbilst pirkuma līgumam, tomēr šo tiesību saņemšanu var ietekmēt vairāki faktori. HP ierobežotā garantija nekādā veidā neierobežo un neietekmē patērētāju likumīgās tiesības. Lai iegūtu plašāku informāciju, izmantojiet šo saiti: Patērētāju likumīgā garantija (www.hp.com/go/eu-legal) vai arī Eiropas Patērētāju tiesību aizsardzības centra tīmekļa vietni (ec.europa.eu/consumers/solving_consumer_disputes/nonjudicial_redress/ecc-net/index_en.htm). Patērētājiem ir tiesības izvēlēties, vai pieprasīt servisa nodrošinājumu saskaņā ar HP ierobežoto garantiju, vai arī pārdevēja sniegto divu gadu garantiju.

Lithuania

HP ribotoji garantija yra HP savanoriškai teikiama komercinė garantija. Toliau pateikiami HP bendrovių, teikiančių HP garantiją (gamintojo garantiją) jūsų šalyje, pavadinimai ir adresai:

Lietuva: HP Finland Oy, PO Box 515, 02201 Espoo, Finland

HP ribotoji garantija papildomai taikoma kartu su bet kokiais kitomis įstatymais nustatytais teisėmis į pardavėjo suteikiamą dviejų metų laikotarpio garantiją dėl prekių atitikties pardavimo sutarčiai, tačiau tai, ar jums ši teisė bus suteikiama, gali priklausyti nuo įvairių aplinkybių. HP ribotoji garantija niekaip neapriboja ir neįtakoja įstatymais nustatytų vartotojo teisių. Daugiau informacijos rasite paspaudę šią nuorodą: Teisinė vartotojo garantija (www.hp.com/go/eu-legal) arba apsilankę Europos vartotojų centro internetinėje svetainėje (ec.europa.eu/consumers/solving_consumer_disputes/nonjudicial_redress/ecc-net/index_en.htm). Vartotojai turi teisę prašyti atlikti techninį aptarnavimą pagal HP ribotąją garantiją arba pardavėjo teikiamą dviejų metų įstatymais nustatytą garantiją.

Estonia

HP piiratud garantii on HP poolt vabatahtlikult pakutav kaubanduslik garantii. HP piiratud garantii eest vastutab HP üksus aadressil:

Eesti: HP Finland Oy, PO Box 515, 02201 Espoo, Finland

HP piiratud garantii rakendub lisaks seaduses ettenähtud müüjapoolsele kaheaastasele garantiile, juhul kui toode ei vasta müügilepingu tingimustele. Siiski võib esineda asjaolusid, mille puhul teie jaoks need õigused ei pruugi kehtida. HP piiratud garantii ei piira ega mõjuta mingil moel tarbija seadusjärgseid õigusi. Lisateavet leiate järgmiselt lingilt: tarbija õiguslik garantii (www.hp.com/go/eu-legal) või võite külastada Euroopa tarbijakeskuste veebisaiti (ec.europa.eu/consumers/solving_consumer_disputes/nonjudicial_redress/ecc-net/index_en.htm). Tarbijal on õigus valida, kas ta soovib kasutada HP piiratud garantiid või seadusega ette nähtud müüjapoolset kaheaastast garantiid.

Russia

Срок службы принтера для России

Срок службы данного принтера HP составляет пять лет в нормальных условиях эксплуатации. Срок службы отсчитывается с момента ввода принтера в эксплуатацию. В конце срока службы HP рекомендует посетить веб-сайт нашей службы поддержки по адресу www.hp.com/support и/или связаться с авторизованным поставщиком услуг HP для получения рекомендаций в отношении дальнейшего безопасного использования принтера.

HP's Premium Protection Warranty: LaserJet toner cartridge limited warranty statement

This HP product is warranted to be free from defects in materials and workmanship.

This warranty does not apply to products that (a) have been refilled, refurbished, remanufactured or tampered with in any way, (b) experience problems resulting from misuse, improper storage, or operation outside of the published environmental specifications for the printer product or (c) exhibit wear from ordinary use.

To obtain warranty service, please return the product to place of purchase (with a written description of the problem and print samples) or contact support. At HP's option, HP will either replace products that prove to be defective or refund your purchase price.

TO THE EXTENT ALLOWED BY LOCAL LAW, THE ABOVE WARRANTY IS EXCLUSIVE AND NO OTHER WARRANTY OR CONDITION, WHETHER WRITTEN OR ORAL, IS EXPRESSED OR IMPLIED AND HP SPECIFICALLY DISCLAIMS

ANY IMPLIED WARRANTIES OR CONDITIONS OF MERCHANTABILITY, SATISFACTORY QUALITY, AND FITNESS FOR A PARTICULAR PURPOSE.

TO THE EXTENT ALLOWED BY LOCAL LAW, IN NO EVENT WILL HP OR ITS SUPPLIERS BE LIABLE FOR DIRECT, SPECIAL, INCIDENTAL, CONSEQUENTIAL (INCLUDING LOST PROFIT OR DATA), OR OTHER DAMAGE, WHETHER BASED IN CONTRACT, TORT, OR OTHERWISE.

THE WARRANTY TERMS CONTAINED IN THIS STATEMENT, EXCEPT TO THE EXTENT LAWFULLY PERMITTED, DO NOT EXCLUDE, RESTRICT OR MODIFY AND ARE IN ADDITION TO THE MANDATORY STATUTORY RIGHTS APPLICABLE TO THE SALE OF THIS PRODUCT TO YOU.

HP policy on non-Original HP supplies

HP cannot recommend the use of non-Original HP toner cartridges, either new or remanufactured.

 **NOTE:** For HP printer products, the use of a non-Original HP toner cartridge or a refilled toner cartridge does not affect either the warranty to the customer or any HP support contract with the customer. However, if product failure or damage is attributable to the use of a non-Original HP toner cartridge or refilled toner cartridge, HP will charge its standard time and materials charges to service the product for the particular failure or damage.

HP anticounterfeit Web site

Go to www.hp.com/go/anticounterfeit when you install an HP toner cartridge and the control-panel message indicates the cartridge is non-Original HP supplies. HP will help determine if the cartridge is genuine and take steps to resolve the problem.

Your toner cartridge might not be a genuine HP toner cartridge if you notice the following:

- The supplies status page indicates that a non-Original HP supply is installed.
- You are experiencing a high number of problems with the cartridge.
- The cartridge does not look like it usually does (for example, the packaging differs from HP packaging).

Data stored on the toner cartridge

The HP toner cartridges used with this product contain a memory chip that assists in the operation of the product.

In addition, this memory chip collects a limited set of information about the usage of the product, which might include the following: the date when the toner cartridge was first installed, the date when the toner cartridge was last used, the number of pages printed using the toner cartridge, the page coverage, the printing modes used, any printing errors that might have occurred, and the product model. This information helps HP design future products to meet our customers' printing needs.

The data collected from the toner cartridge memory chip does not contain information that can be used to identify a customer or user of the toner cartridge or their product.

HP collects a sampling of the memory chips from toner cartridges returned to HP's free return and recycling program (HP Planet Partners: www.hp.com/recycle). The memory chips from this sampling are read and studied in order to improve future HP products. HP partners who assist in recycling this toner cartridge might have access to this data, as well.

Any third party possessing the toner cartridge might have access to the anonymous information on the memory chip.

End User License Agreement

READ CAREFULLY BEFORE USING THIS SOFTWARE EQUIPMENT:

This End-User License Agreement ("EULA") is a legal agreement between (a) you (either an individual or a single entity) and (b) HP Inc. ("HP") that governs your use of any Software Product, installed on or made available by HP for use with your HP product ("HP Product"), that is not otherwise subject to a separate license agreement between you and HP or its suppliers. Other software may contain a EULA in its online documentation. The term "Software Product" means computer software and may include associated media, printed materials and "online" or electronic documentation.

An amendment or addendum to this EULA may accompany the HP Product.

RIGHTS IN THE SOFTWARE PRODUCT ARE OFFERED ONLY ON THE CONDITION THAT YOU AGREE TO ALL TERMS AND CONDITIONS OF THIS EULA. BY INSTALLING, COPYING, DOWNLOADING, OR OTHERWISE USING THE SOFTWARE PRODUCT, YOU AGREE TO BE BOUND BY THE TERMS OF THIS EULA. IF YOU DO NOT ACCEPT THESE LICENSE TERMS, YOUR SOLE REMEDY IS TO RETURN THE ENTIRE UNUSED PRODUCT (HARDWARE AND SOFTWARE) WITHIN 14 DAYS FOR A REFUND SUBJECT TO THE REFUND POLICY OF YOUR PLACE OF PURCHASE.

THIS EULA IS A GLOBAL AGREEMENT AND IS NOT SPECIFIC TO ANY PARTICULAR COUNTRY, STATE OR TERRITORY. IF YOU ACQUIRED THE SOFTWARE AS A CONSUMER WITHIN THE MEANING OF RELEVANT CONSUMER LEGISLATION IN YOUR COUNTRY, STATE OR TERRITORY, THEN DESPITE ANYTHING TO THE CONTRARY IN THIS EULA, NOTHING IN THIS EULA AFFECTS ANY NON EXCLUDABLE STATUTORY RIGHTS OR REMEDIES THAT YOU MAY HAVE UNDER SUCH CONSUMER LEGISLATION AND THIS EULA IS SUBJECT TO THOSE RIGHTS AND REMEDIES. REFER TO SECTION 16 FOR FURTHER INFORMATION ON YOUR CONSUMER RIGHTS.

1. **GRANT OF LICENSE.** HP grants you the following rights provided you comply with all terms and conditions of this EULA:
 - a. **Use.** You may use the Software Product on a single computer ("Your Computer"). If the Software Product is provided to you via the internet and was originally licensed for use on more than one computer, you may install and use the Software Product only on those computers. You may not separate component parts of the Software Product for use on more than one computer. You do not have the right to distribute the Software Product, nor do you have the right to modify the Software Product or disable any licensing or control feature of the Software Product. You may load the Software Product into Your Computer's temporary memory (RAM) for purposes of using the Software Product.
 - b. **Storage.** You may copy the Software Product into the local memory or storage device of the HP Product.
 - c. **Copying.** You may make archival or back-up copies of the Software Product, provided the copy contains all of the original Software Product's proprietary notices and that it is used only for back-up purposes.
 - d. **Reservation of Rights.** HP and its suppliers reserve all rights not expressly granted to you in this EULA.
 - e. **Freeware.** Notwithstanding the terms and conditions of this EULA, all or any portion of the Software Product which constitutes non-proprietary HP software or software provided under public license by third parties ("Freeware"), is licensed to you subject to the terms and conditions of the software license agreement accompanying such Freeware whether in the form of a discrete agreement, shrink wrap license or electronic license terms accepted at time of download. Use of the Freeware by you shall be governed entirely by the terms and conditions of such license.

- f. **Recovery Solution.** Any software recovery solution provided with/for your HP Product, whether in the form of a hard disk drive-based solution, an external media-based recovery solution (e.g. floppy disk, CD or DVD) or an equivalent solution delivered in any other form, may only be used for restoring the hard disk of the HP Product with/for which the recovery solution was originally purchased. The use of any Microsoft operating system software contained in such recovery solution shall be governed by the Microsoft License Agreement.
- 2. **UPGRADES.** To use a Software Product identified as an upgrade, you must first be licensed for the original Software Product identified by HP as eligible for the upgrade. After upgrading, you may no longer use the original Software Product that formed the basis for your upgrade eligibility. By using the Software Product, you also agree that HP may automatically access your HP Product when connected to the internet to check the version or status of certain Software Products and may automatically download and install upgrades or updates to such Software Products on to your HP Product to provide new versions or updates required to maintain the functionality, performance, or security of the Software Product and your HP Product and facilitate the provision of support or other services provided to you. In certain cases, and depending on the type of upgrade or update, notifications will be provided to you (via pop-up or other means), which may require you to initiate the upgrade or update.
- 3. **ADDITIONAL SOFTWARE.** This EULA applies to updates or supplements to the original Software Product provided by HP unless HP provides other terms along with the update or supplement. In case of a conflict between such terms, the other terms will prevail.
- 4. **TRANSFER.**
 - a. **Third Party.** The initial user of the Software Product may make a one-time transfer of the Software Product to another end user. Any transfer must include all component parts, media, printed materials, this EULA, and if applicable, the Certificate of Authenticity. The transfer may not be an indirect transfer, such as a consignment. Prior to the transfer, the end user receiving the transferred product must agree to all the EULA terms. Upon transfer of the Software Product, your license is automatically terminated.
 - b. **Restrictions.** You may not rent, lease or lend the Software Product or use the Software Product for commercial timesharing or bureau use. You may not sublicense, assign or transfer the license or Software Product except as expressly provided in this EULA.
- 5. **PROPRIETARY RIGHTS.** All intellectual property rights in the Software Product and user documentation are owned by HP or its suppliers and are protected by law, including but not limited to United States copyright, trade secret, and trademark law, as well as other applicable laws and international treaty provisions. You shall not remove any product identification, copyright notices or proprietary restrictions from the Software Product.
- 6. **LIMITATION ON REVERSE ENGINEERING.** You may not reverse engineer, decompile, or disassemble the Software Product, except and only to the extent that the right to do so is mandated under applicable law notwithstanding this limitation or it is expressly provided for in this EULA.
- 7. **TERM.** This EULA is effective unless terminated or rejected. This EULA will also terminate upon conditions set forth elsewhere in this EULA or if you fail to comply with any term or condition of this EULA.
- 8. **NOTICE OF DATA COLLECTION.**

CONSENT TO COLLECTION/USE OF DATA.

- a. You agree that HP and its affiliates may collect, combine, and use device and individual user information you provide in relation to support services related to the Software Product. HP agrees not to use this information to market to you without your consent. Learn More about HP data collection practices at www.hp.com/go/privacy

- b. HP will use cookies and other web technology tools to collect anonymous technical information related to HP Software and your HP Product. This data will be used to provide the upgrades and related support or other services described in Section 2. HP will also collect personal information including your Internet Protocol address or other unique identifier information associated with your HP Product and data provided by you on registration of your HP Product. As well as providing the upgrades and related support or other services, this data will be used for sending marketing communications to you (in each case with your express consent where required by applicable law).

To the extent permitted by applicable law, by accepting these terms and conditions you consent to the collection and use of anonymous and personal data by HP, its subsidiaries, and affiliates as described in this EULA and as further described in HP's privacy policy: www.hp.com/go/privacy

- c. **Collection/Use by Third Parties.** Certain software programs included in your HP Product are provided and separately licensed to you by third party providers ("Third Party Software"). Third Party Software may be installed and operational on your HP Product even if you choose not to activate/purchase such software. Third Party Software may collect and transmit technical information about your system (i.e., IP address, unique device identifier, software version installed, etc.) and other system data. This information is used by the third party to identify technical system attributes and ensure that the most current version of the software has been installed on your system. If you do not want the Third Party Software to collect this technical information or automatically send you version updates, you should uninstall the software prior to connecting to the Internet.
- 9. DISCLAIMER OF WARRANTIES.** TO THE MAXIMUM EXTENT PERMITTED BY APPLICABLE LAW, HP AND ITS SUPPLIERS PROVIDE THE SOFTWARE PRODUCT "AS IS" AND WITH ALL FAULTS, AND HEREBY DISCLAIM ALL OTHER WARRANTIES, DUTIES, AND CONDITIONS, EITHER EXPRESS, IMPLIED, OR STATUTORY, INCLUDING, BUT NOT LIMITED TO, WARRANTIES: (i) OF TITLE AND NON-INFRINGEMENT; (ii) OF MERCHANTABILITY; (iii) OF FITNESS FOR A PARTICULAR PURPOSE; (iv) THAT THE SOFTWARE PRODUCT WILL FUNCTION WITH NON-HP SUPPLIES OR ACCESSORIES; AND (v), OF LACK OF VIRUSES ALL WITH REGARD TO THE SOFTWARE PRODUCT. Some states/jurisdictions do not allow exclusion of implied warranties or limitations on the duration of implied warranties, so the above disclaimer may not apply to you in its entirety.
- 10. LIMITATION OF LIABILITY.** Subject to the laws of the People's Republic of China, notwithstanding any damages that you might incur, the entire liability of HP and any of its suppliers under any provision of this EULA and your exclusive remedy for all of the foregoing shall be limited to the greater of the amount actually paid by you separately for the Software Product or U.S. \$5.00. TO THE MAXIMUM EXTENT PERMITTED BY APPLICABLE LAW, IN NO EVENT SHALL HP OR ITS SUPPLIERS BE LIABLE FOR ANY SPECIAL, INCIDENTAL, INDIRECT, OR CONSEQUENTIAL DAMAGES WHATSOEVER (INCLUDING, BUT NOT LIMITED TO, DAMAGES FOR LOSS OF PROFITS OR CONFIDENTIAL OR OTHER INFORMATION, FOR BUSINESS INTERRUPTION, FOR PERSONAL INJURY, OR FOR LOSS OF PRIVACY) ARISING OUT OF OR IN ANY WAY RELATED TO THE USE OF OR INABILITY TO USE THE SOFTWARE PRODUCT, OR OTHERWISE IN CONNECTION WITH ANY PROVISION OF THIS EULA, EVEN IF HP OR ANY SUPPLIER HAS BEEN ADVISED OF THE POSSIBILITY OF SUCH DAMAGES AND EVEN IF THE REMEDY FAILS OF ITS ESSENTIAL PURPOSE. Some states/jurisdictions do not allow the exclusion or limitation of incidental or consequential damages, so the above limitation or exclusion may not apply to you.
- 11. U.S. GOVERNMENT CUSTOMERS.** Consistent with FAR 12.211 and 12.212, Commercial Computer Software, Computer Software Documentation, and Technical Data for Commercial Items are licensed to the U.S. Government under HP's standard commercial license.
- 12. COMPLIANCE WITH EXPORT LAWS.** You shall comply with all laws and regulations of the United States and other countries ("Export Laws") to assure that the Software Product is not (1) exported, directly or indirectly, in violation of Export Laws, or (2) used for any purpose prohibited by Export Laws, including, without limitation, nuclear, chemical, or biological weapons proliferation.
- 13. CAPACITY AND AUTHORITY TO CONTRACT.** You represent that you are of the legal age of majority in your state of residence and, if applicable, you are duly authorized by your employer to enter into this contract.

- 14. APPLICABLE LAW.** This EULA is governed by the laws of the country in which the equipment was purchased.
- 15. ENTIRE AGREEMENT.** This EULA (including any addendum or amendment to this EULA which is included with the HP Product) is the entire agreement between you and HP relating to the Software Product and it supersedes all prior or contemporaneous oral or written communications, proposals and representations with respect to the Software Product or any other subject matter covered by this EULA. To the extent the terms of any HP policies or programs for support services conflict with the terms of this EULA, the terms of this EULA shall control.
- 16. CONSUMER RIGHTS.** Consumers in some countries, states or territories may have the benefit of certain statutory rights and remedies under consumer legislation in respect of which HP's liability cannot lawfully be excluded or limited. If you acquired the Software as a consumer within the meaning of relevant consumer legislation in your country, state or territory, the provisions of this EULA (including the disclaimers of warranties, limitations and exclusions of liability) must be read subject to applicable law and apply only to the maximum extent permitted by that applicable law.

Australian Consumers: If you acquired the Software as a consumer within the meaning of the 'Australian Consumer Law' under the Australian Competition and Consumer Act 2010 (Cth) then despite any other provision of this EULA:

- a. the Software comes with guarantees that cannot be excluded under the Australian Consumer Law, including that goods will be of acceptable quality and services will be supplied with due care and skill. You are entitled to a replacement or refund for a major failure and compensation for any other reasonably foreseeable loss or damage. You are also entitled to have the Software repaired or replaced if it is not of acceptable quality and the failure does not amount to a major failure.
- b. nothing in this EULA excludes, restricts or modifies any right or remedy, or any guarantee, warranty or other term or condition implied or imposed by the Australian Consumer Law which cannot be lawfully excluded or limited; and
- c. the benefits provided to you by the express warranties in this EULA are in addition to other rights and remedies available to you under the Australian Consumer Law. Your rights under the Australian Consumer Law prevail to the extent that they are inconsistent with any limitations contained in the express warranty.
- d. The Software may be capable of retaining user-generated data. HP hereby provides you with notice that if HP repairs your Software, that repair may result in the loss of that data. To the full extent permitted by law, the limitations and exclusions of HP's liability in this EULA apply in respect of any such loss of data.

If you think that you are entitled to any warranty under this agreement or any of the above remedies, please contact HP:

HP PPS Australia Pty Ltd

Rhodes Corporate Park, Building F, Level 5

1 Homebush Bay Drive

Rhodes, NSW 2138

Australia

To initiate a support request or warranty claim, please call 13 10 47 (within Australia) or +61 2 8278 1039 (if dialing internationally) or visit www8.hp.com/au/en/contact-hp/phone-assist.html for the most current list of phone support numbers.

If you are a consumer within the meaning of the Australia Consumer Law and you are purchasing the Software or warranty and support services for the Software which are not of a kind ordinarily acquired for personal, domestic or household use or consumption, then despite any other provision of this EULA, HP limits its liability for failure to comply with a consumer guarantee as follows:

- a. provision of warranty or support services for the Software: to any one or more of the following: re-supply of the services or payment of the costs of having the services re-supplied;
- b. provision of the Software: to any one or more of the following: replacement of the Software or the supply of equivalent software; repair of the Software; payment of the costs of replacing the Software or of acquiring equivalent software; or payment of the costs of having the Software repaired; and
- c. otherwise, to the maximum extent permitted by law.

New Zealand Consumers: In New Zealand, the Software comes with guarantees that cannot be excluded under the Consumer Guarantees Act 1993. In New Zealand, Consumer Transaction means a transaction involving a person who is purchasing goods for personal, domestic or household use or consumption and not for the purpose of a business. New Zealand consumers who are purchasing goods for personal, domestic or household use or consumption and not for the purpose of a business ("New Zealand Consumers") are entitled to repair, replacement or refund for a failure and compensation for other reasonably foreseeable loss or damage. A New Zealand Consumer (as defined above) may recover the costs of returning the product to the place of purchase if there is a breach of the New Zealand consumer law; furthermore, if it will be of significant cost to the New Zealand Consumer to return the goods to HP then HP will collect such goods at its own cost. Where any supply of products or services is for business purposes, you agree that the Consumer Guarantees Act 1993 does not apply and that given the nature and value of the transaction, this is fair and reasonable.

© Copyright 2021 HP Development Company, L.P.

The information contained herein is subject to change without notice. All other product names mentioned herein may be trademarks of their respective companies. To the extent permitted by applicable law, the only warranties for HP products and services are set forth in the express warranty statements accompanying such products and services. Nothing herein should be construed as constituting an additional warranty. To the extent permitted by applicable law, HP shall not be liable for technical or editorial errors or omissions contained herein.

Customer self-repair warranty service

HP products are designed with many Customer Self Repair (CSR) parts to minimize repair time and allow for greater flexibility in performing defective parts replacement. If during the diagnosis period, HP identifies that the repair can be accomplished by the use of a CSR part, HP will ship that part directly to you for replacement. There are two categories of CSR parts: 1) Parts for which customer self repair is mandatory. If you request HP to replace these parts, you will be charged for the travel and labor costs of this service. 2) Parts for which customer self repair is optional. These parts are also designed for Customer Self Repair. If, however, you require that HP replace them for you, this may be done at no additional charge under the type of warranty service designated for your product.

Based on availability and where geography permits, CSR parts will be shipped for next business day delivery. Same-day or four-hour delivery may be offered at an additional charge where geography permits. If assistance is required, you can call the HP Technical Support Center and a technician will help you over the phone. HP specifies in the materials shipped with a replacement CSR part whether a defective part must be returned to HP. In cases where it is required to return the defective part to HP, you must ship the defective part back to HP within a defined period of time, normally five (5) business days. The defective part must be returned with the associated documentation in the provided shipping material. Failure to return the defective part may result in HP billing you for the replacement. With a customer self repair, HP will pay all shipping and part return costs and determine the courier/carrier to be used.

Customer support

Table B-3 Customer Support

Support	URL links
Get telephone support for your country/region Have the product name, serial number, date of purchase, and problem description ready.	Country/region phone numbers are on the flyer that was in the box with your product or at www.hp.com/support
Get 24-hour Internet support, and download software utilities and drivers	www.hp.com/support
Order additional HP service or maintenance agreements	www.hp.com/go/carepack
Register your product	www.register.hp.com

C Environmental product stewardship program

This section describes the environmental-friendly product stewardship program at HP.

Protecting the environment

HP is committed to providing quality products in an environmentally sound manner. This product has been designed with several attributes to minimize impacts on our environment.

Ozone production

The airborne emissions of ozone for this product have been measured according to a standardized protocol and when these emissions data are applied to an anticipated high-use scenario in an office workspace, HP has determined there is no appreciable amount of ozone generated during printing and the levels are well within current indoor air quality standards and guidelines.

References -

Test method for the determination of emissions from hardcopy devices with respect to awarding the environmental label for office devices with printing function; DE-UZ 205 – BAM; January 2018.

Based on ozone concentration when printing 2 hours per day in 30.6 cubic meter room with a ventilation rate of 0.68 air changes per hour with HP printing supplies.

Power consumption

Power usage drops significantly while in Ready, Sleep, or Off mode, which saves natural resources and saves money without affecting the high performance of this product. HP printing and imaging equipment marked with the ENERGY STAR® logo is qualified to the U.S. Environmental Protection Agency's ENERGY STAR specifications for imaging equipment. The following mark will appear on ENERGY STAR qualified imaging products:



Additional ENERGY STAR qualified imaging product model information is listed at:

www.hp.com/go/energystar

Toner consumption

EconoMode uses less toner, which might extend the life of the print cartridge. HP does not recommend the full-time use of EconoMode. If EconoMode is used full-time, the toner supply might outlast the mechanical parts in the print cartridge. If print quality begins to degrade and is no longer acceptable, consider replacing the print cartridge.

Paper use

This product's duplex feature (manual or automatic) and N-up printing (multiple pages printed on one page) capability can reduce paper usage and the resulting demands on natural resources.

Plastics

Plastic parts over 25 grams are marked according to international standards that enhance the ability to identify plastics for recycling purposes at the end of the product's life.

HP LaserJet print supplies

Original HP Supplies were designed with the environment in mind. HP makes it easy to conserve resources and paper when printing. And when you are done, we make it easy and free to recycle.¹

All HP cartridges returned to HP Planet Partners go through a multiphase recycling process where materials are separated and refined for use as raw material in new Original HP cartridges and everyday products. No Original HP cartridges returned through HP Planet Partners are ever sent to a landfill, and HP never refills or resells Original HP cartridges.

To participate in HP Planet Partners return and recycling program, visit www.hp.com/recycle. Select your country/region for information on how to return HP printing supplies. Multi-lingual program information and instructions are also included in every new HP LaserJet print cartridge package.

¹ Program availability varies. For more information, visit www.hp.com/recycle

Paper

This product is capable of using recycled paper and lightweight paper (EcoFFICIENT™) when the paper meets the guidelines outlined in the *HP Laser Printer Family Print Media Guide*. This product is suitable for the use of recycled paper and lightweight paper (EcoFFICIENT™) according to EN12281:2002.

Material restrictions

This HP product does not contain added mercury.

Disposal of waste equipment by users (EU and India)



This symbol means do not dispose of your product with your other household waste. Instead, you should protect human health and the environment by handing over your waste equipment to a designated collection point for the recycling of waste electrical and electronic equipment. For more information, please contact your household waste disposal service, or go to: www.hp.com/recycle

Electronic hardware recycling

HP encourages customers to recycle used electronic hardware. For more information about recycling programs go to: www.hp.com/recycle

Hardware recycling information (Brazil)



**Não descarte o
produto eletrônico
em lixo comum**

Este produto eletrônico e seus componentes não devem ser descartados no lixo comum, pois embora estejam em conformidade com padrões mundiais de restrição a substâncias nocivas, podem conter, ainda que em quantidades mínimas, substâncias impactantes ao meio ambiente. Ao final da vida útil deste produto, o usuário deverá entregá-lo à HP. A não observância dessa orientação sujeitará o infrator às sanções previstas em lei.

Após o uso, as pilhas e/ou baterias dos produtos HP deverão ser entregues ao estabelecimento comercial ou rede de assistência técnica autorizada pela HP.

Para maiores informações, inclusive sobre os pontos de recebimento, acesse:

www8.hp.com/br/pt/ads/planet-partners/index.html

Chemical substances



HP is committed to providing our customers with information about the chemical substances in our products as needed to comply with legal requirements such as REACH (Regulation EC No 1907/2006 of the European Parliament and the Council). A chemical information report for this product can be found at: www.hp.com/go/reach

Product Power Data per European Union Commission Regulation 1275/2008

For product power data, including the power consumption of the product in networked standby if all wired network ports are connected and all wireless network ports are activated, please refer to section P14 'Additional Information' of the product IT ECO Declaration at www.hp.com/hpinfo/globalcitizenship/environment/productdata/itecodesktop-pc.html

SEPA Ecolabel User Information (China)

中国环境标识认证产品用户说明

噪声大于 63.0 dB(A)的办公设备不宜放置于办公室内，请在独立的隔离区域使用。

如需长时间使用本产品或打印大量文件，请确保在通风良好的房间内使用。

如您需要确认本产品处于零能耗状态，请按下电源关闭按钮，并将插头从电源插座断开。

您可以使用再生纸，以减少资源耗费。

The regulation of the implementation on China energy label for printer, and copier

依据“复印机、打印机和传真机能源效率标识实施规则”，本打印机具有中国能效标签。根据“复印机、打印机和传真机能效限定值及能效等级”（“GB21521”）决定并计算得出该标签上所示的能效等级和 TEC（典型能耗）值。

1. 能效等级

能效等级分为三个等级，等级 1 级能效最高。根据产品类型和打印速度标准决定能效限定值。

2. 能效信息

2.1 激光打印机及一体机和高性能喷墨打印机及一体机

- 典型能耗

典型能耗是正常运行 GB21521 测试方法中指定的时间后的耗电量。此数据表示为每周千瓦时 (kWh)。

标签上所示的能效数字按涵盖根据“复印机、打印机和传真机能源效率标识实施规则”选择的登记装置中所有配置的代表性配置测定而得。因此，本特定产品型号的实际能耗可能与标签上所示的数据不同。

有关规范的详情信息，请参阅 GB21521 标准的当前版本。

Restriction of Hazardous Substances statement (India)

This product, as well as its related consumables and spares, complies with the reduction in hazardous substances provisions of the "India E-waste Rule 2016." It does not contain lead, mercury, hexavalent chromium, polybrominated biphenyls or polybrominated diphenyl ethers in concentrations exceeding 0.1 weight % and 0.01 weight % for cadmium, except where allowed pursuant to the exemptions set in Schedule 2 of the Rule.

WEEE (Turkey)

Türkiye Cumhuriyeti: AEEE Yönetmeliğine Uygundurp

The Table of Hazardous Substances/Elements and their Content (China)

电器电子产品中有毒物质的名称及含有信息表

The Table of names and content information of hazardous substances

in electrical and electronic products

根据中国《电器电子产品有害物质限制使用管理办法》

As required by China's Management Methods for Restricted Use of

Hazardous Substances in Electrical and Electronic Products



产品中有毒物质的名称及含有的信息表										
Table of names and content information of hazardous substances in the products										
部件名称 Part name	有害物质 Hazardous substances									
	铅 (Pb)	汞 (Hg)	镉 (Cd)	六价铬 (Cr(VI))	多溴联苯 (PBBs)	多溴二苯醚 (PBDEs)	邻苯二甲酸 二正丁酯 (DBP)	邻苯二甲 酸二异丁 酯 (DIBP)	邻苯二甲 酸丁苄酯 (BBP)	邻苯二甲 酸二(2- 乙基)己 酯 (DEHP)
打印引擎	×	○	○	○	○	○	○	○	○	○
复印机组件	×	○	○	○	○	○	○	○	○	○
控制面板	×	○	○	○	○	○	○	○	○	○
塑料外壳	○	○	○	○	○	○	○	○	○	○
格式化板组件	×	○	○	○	○	○	○	○	○	○
碳粉盒	×	○	○	○	○	○	○	○	○	○

注 1：○：表示该有害物质在该部件所有均质材料中的含量均不超出电器电子产品有害物质限制使用国家标准要求。
Note 1: ○: denotes that the content of said hazardous substance in all of the homogeneous materials in the said part does not exceed the limits given in the national standard regarding restricted use of hazardous substances in electrical and electronic products.

×：表示该有害物质至少在该部件的某一均质材料中的含量超出电器电子产品有害物质限制使用国家标准要求。
×: denotes that the content of said hazardous substance in at least one of the homogeneous materials in the said part exceeds the limits given in the national standard regarding restricted use of hazardous substances in electrical and electronic products.

注 2：以上未列出的部件,表明其有害物质含量均不超出电器电子产品有害物质限制使用国家标准要求。
Note 2: Parts not listed above indicate that the content of hazardous substances contained therein does not exceed the limits given in the national standard regarding restricted use of hazardous substances in electrical and electronic products.

Material Safety Data Sheet (MSDS)

Material Safety Data Sheets (MSDS) for supplies containing chemical substances (for example, toner) can be obtained by accessing the HP Web site at www.hp.com/go/msds

EPEAT

Many HP products are designed to meet EPEAT. EPEAT is a comprehensive environmental rating that helps identify greener electronics equipment. For more information on EPEAT go to www.epeat.net. For information on HP's EPEAT registered products go to www8.hp.com/us/en/hp-information/global-citizenship/index.html

Declaration of the Presence Condition of the Restricted Substances Marking (Taiwan)

台灣 限用物質含有情況標示聲明書

Taiwan Declaration of the Presence Condition of the Restricted Substances Marking

單元 Unit	限用物質及其化學符號 Restricted substances and its chemical symbols					
	鉛Lead (Pb)	汞Mercury (Hg)	鎘Cadmium (Cd)	六價鉻 Hexavalent chromium (Cr ⁺⁶)	多溴聯苯 Polybrominated biphenyls (PBB)	多溴二苯醚 Polybrominated diphenyl ethers (PBDE)
列印引擎 Print engine	—	○	○	○	○	○
外殼和紙匣 External Casing and Trays	○	○	○	○	○	○
電源供應器 Power Supply	—	○	○	○	○	○
電線 Cables	○	○	○	○	○	○
印刷電路板 Print printed circuit board	—	○	○	○	○	○
控制面板 Control panel	—	○	○	○	○	○
碳粉匣 Cartridge	○	○	○	○	○	○
掃描器組件 Scanner assembly	—	○	○	○	○	○

備考1. “超出0.1 wt %”及“超出0.01 wt %”係指限用物質之百分比含量超出百分比含量基準值。
Note 1: “Exceeding 0.1 wt %” and “exceeding 0.01 wt %” indicate that the percentage content of the restricted substance exceeds the reference percentage value of presence condition.

備考2. “○”係指該項限用物質之百分比含量未超出百分比含量基準值。
Note 2: “○” indicates that the percentage content of the restricted substance does not exceed the percentage of reference value of presence.

備考3. “—”係指該項限用物質為排除項目。
Note 3: The “—” indicates that the restricted substance corresponds to the exemption.

TWR-LJ-PK-MFP-02

若要存取產品的最新使用指南或手冊，請前往 hp.com/support。選取搜尋您的產品，然後依照畫面上的指示繼續執行。

To access the latest user guides or manuals for your product, go to hp.com/support. Select Find your product, and then follow the on-screen instructions.

For more information

To obtain information about these environmental topics:

- Product environmental profile sheet for this and many related HP products
- HP's commitment to the environment
- HP's environmental management system
- HP's end-of-life product return and recycling program
- Material Safety Data Sheets

Visit www.hp.com/go/environment

Also, visit www.hp.com/recycle

D Regulatory information

This section describes the regulatory statements.

Battery Statements

Reese's Law

⚠ WARNING	
<ul style="list-style-type: none">• INGESTION HAZARD: This product contains a button cell or coin battery.• DEATH or serious injury can occur if ingested.• A swallowed button cell or coin battery can cause Internal Chemical Burns in as little as 2 hours.• KEEP new and used batteries OUT OF REACH of CHILDREN.• Seek immediate medical attention if a battery is suspected to be swallowed or inserted inside any part of the body.	
⚠ WARNING	INGESTION HAZARD: This product contains a button cell or coin battery.

- Remove and immediately recycle or dispose of used batteries according to local regulations and keep away from children. Do NOT dispose of batteries in household trash or incinerate.
- Even used batteries may cause severe injury or death.
- Call a local poison control center for treatment information.
- Non-rechargeable batteries are not to be recharged.
- Do not force discharge, recharge, disassemble, heat above (manufacturer's specified temperature rating) or incinerate. Doing so may result in injury due to venting, leakage or explosion resulting in chemical burns.
- This product contains a non-replaceable battery. It is NOT intended to be replaced.
- This product uses a NON replaceable battery. The coin/button cell battery type/model could be either: CR1632, CR1225 or CR2032.
- The nominal battery voltage of this battery is 3v DC.

UK Battery

Unfortunately, it is not obvious when a button or coin battery is stuck in a child's oesophagus (food pipe). There are no specific symptoms associated with this. The child might:

- Cough, gag or drool a lot
- Appear to have a stomach upset or a virus
- Be sick

- Point to their throat or stomach
- Have a pain in their abdomen, chest or throat
- Be tired or lethargic
- Be quieter or more clingy than usual or otherwise “not themselves”
- Lose their appetite or have a reduced appetite
- Not want to eat solid food/be unable to eat solid food

These sorts of symptoms vary or fluctuate, with the pain increasing and then subsiding.

A specific symptom to button and coin battery ingestion is vomiting fresh (bright red) blood. If the child does this seek immediate medical help.

The lack of clear symptoms is why it is important to be vigilant with “flat” or spare button or coin batteries in the home and the products that contain them.

Regulatory statements

The printer meets product requirements from regulatory agencies in your country/region.

European Union and United Kingdom Regulatory Notice



Products bearing the CE marking and UK marking comply to applicable EU Directives and the equivalent UK Statutory Instruments and can operate in at least one EU Member State and in United Kingdom. The full EU and UK Declaration of Conformity can be found at the following website: hp.eu/certificates (Search with the product model name or its Regulatory Model Number (RMN), which may be found on the regulatory label.)

The point of contact for regulatory matters:

For EU: HP REG 23010, 08028 Barcelona, Spain

For UK: HP Inc UK Ltd, Regulatory Enquiries, Earley West, 300 Thames Valley Park Drive, Reading, RG6 1PT

Email: reg@hp.com

Regulatory model numbers

For regulatory identification purposes, your product is assigned a regulatory model number. Regulatory model numbers should not be confused with marketing names or product numbers.

Table D-1 Regulatory model numbers

Product model number	Regulatory model number
HP LaserJet Pro MFP 3101fdne	SHNGC-2001-00
HP LaserJet Pro MFP 3101fdn	
HP LaserJet Pro MFP 3102fdne	
HP LaserJet Pro MFP 3102fdn	
HP LaserJet Pro MFP 3103fdn	
HP LaserJet Pro MFP 3104fdn	
HP LaserJet Pro MFP 3101fdwe	SHNGC-2001-01
HP LaserJet Pro MFP 3101fdw	
HP LaserJet Pro MFP 3102fdwe	
HP LaserJet Pro MFP 3102fdw	
HP LaserJet Pro MFP 3103fdw	
HP LaserJet Pro MFP 3104fdw	
HP LaserJet Pro MFP 3101sdw	SHNGC-2001-02

FCC regulations

This equipment has been tested and found to comply with the limits for a Class B digital device, pursuant to Part 15 of the FCC rules. These limits are designed to provide reasonable protection against harmful interference in a residential installation. This equipment generates, uses, and can radiate radio frequency energy. If this equipment is not installed and used in accordance with the instructions, it may cause harmful interference to radio communications. However, there is no guarantee that interference will not occur in a particular installation. If this equipment does cause harmful interference to radio or television reception, which can be determined by turning the equipment off and on, the user is encouraged to try to correct the interference by one or more of the following measures:

- Reorient or relocate the receiving antenna.
- Increase separation between equipment and receiver.
- Connect equipment to an outlet on a circuit different from that to which the receiver is located.
- Consult your dealer or an experienced radio/TV technician.



NOTE: Any changes or modifications to the printer that are not expressly approved by HP could void the user's authority to operate this equipment.

Use of a shielded interface cable is required to comply with the Class B limits of Part 15 of FCC rules.

Canada - Industry Canada ICES-003 Compliance Statement

CAN ICES-3(B)/NMB-3(B)

Power cord instructions

Make sure your power source is adequate for the product voltage rating. The voltage rating is on the product label. The product uses either 110-127 Vac or 220-240 Vac and 50/60 Hz.

Connect the power cord between the product and a grounded AC outlet.

⚠ CAUTION: To prevent damage to the product, use only the power cord that is provided with the product.

Laser safety

The Center for Devices and Radiological Health (CDRH) of the U.S. Food and Drug Administration has implemented regulations for laser products manufactured since August 1, 1976. Compliance is mandatory for products marketed in the United States. The device is certified as a "Class 1" laser product under the U.S. Department of Health and Human Services (DHHS) Radiation Performance Standard according to the Radiation Control for Health and Safety Act of 1968. Since radiation emitted inside the device is completely confined within protective housings and external covers, the laser beam cannot escape during any phase of normal user operation.

⚠ WARNING! Using controls, making adjustments, or performing procedures other than those specified in this user guide may result in exposure to hazardous radiation.

For other US/Canada regulatory matters, please contact:

HP Inc.

HP Inc. 1501 Page Mill Rd, Palo Alto, CA 94304, USA

Email contact: (techregshelp@hp.com) or Telephone contact: +1 (650) 857-1501

Laser statement for Finland

Luokan 1 laserlaite

HP LaserJet Pro MFP 3101-3108, laserkirjoitin on käyttäjän kannalta turvallinen luokan 1 laserlaite. Normaalisissa käytössä kirjoittimen suojakoteloointi estää lasersäteen pääsyn laitteen ulkopuolelle. Laitteen turvallisuusluokka on määritetty standardin EN 60825-1 (2014) mukaisesti.

VAROITUS !

Laitteen käyttäminen muulla kuin käyttöohjeessa mainitulla tavalla saattaa altistaa käyttäjän turvallisuusluokan 1 ylittävälle näkymättömälle lasersäteilylle.

WARNING !

Om apparaten används på annat sätt än i bruksanvisning specificerats, kan användaren utsättas för osynlig laserstrålning, som överskrider gränsen för laserklass 1.

HUOLTO

HP LaserJet Pro MFP 3101-3108 - kirjoittimen sisällä ei ole käyttäjän huollettavissa olevia kohteita. Laitteen saa avata ja huoltaa ainoastaan sen huoltamiseen koulutettu henkilö. Tällaiseksi huoltotoimenpiteeksi ei katsota väriainekasetin vaihtamista, paperiradan puhdistusta tai muita käyttäjän käsikirjassa lueteltuja, käyttäjän tehtäväksi tarkoitettuja ylläpitotoimia, jotka voidaan suorittaa ilman erikoistyökaluja.

VARO !

Mikäli kirjoittimen suojakotelo avataan, olet alttiina näkymättömällelasersäteilylle laitteen ollessa toiminnassa. Älä katso säteeseen.

WARNING !

Om laserprinterns skyddshölje öppnas då apparaten är i funktion, utsätts användaren för osynlig laserstrålning. Betrakta ej strålen.

Tiedot laitteessa käytettävän laserdiodin säteilyominaisuuksista: Aallonpituus 775-795 nm Teho 5 m W Luokan 3B laser.

GS statement (Germany)

Das Gerät ist nicht für die Benutzung im unmittelbaren Gesichtsfeld am Bildschirmarbeitsplatz vorgesehen. Um störende Reflexionen am Bildschirmarbeitsplatz zu vermeiden, darf dieses Produkt nicht im unmittelbaren Gesichtsfeld platziert werden.

Das Gerät ist kein Bildschirmarbeitsplatz gemäß BildscharbV. Bei ungünstigen Lichtverhältnissen (z. B. direkte Sonneneinstrahlung) kann es zu Reflexionen auf dem Display und damit zu Einschränkungen der Lesbarkeit der dargestellten Zeichen kommen.

Die Bildarstellung dieses Gerätes ist nicht für verlängerte Bildschirmtätigkeiten geeignet.

Nordic Statements (Denmark, Finland, Norway, Sweden)

Denmark:

Apparatets stikprop skal tilsattes en stikkontakt med jord, som giver forbindelse til stikproppens jord.

Finland:

Laite on liitettävä suojakoskettimilla varustettuun pistorasiaan.

Norway:

Apparatet må tilkoples jordet stikkontakt.

Sweden:

Apparaten skall anslutas till jordat uttag.

Taiwan BSMI USB Port (Walk-up) Statement

The front USB port (walk-up port) located at the front, top, or side of the product is typically used with thumb drives.

Eurasian Conformity (Armenia, Belarus, Kazakhstan, Kirgizstan, Russia)

Производитель и дата производства



HP Inc.

Адрес: 1501 Page Mill Road, Palo Alto, California 94304, U.S.

Дата производства зашифрована в 10-значном серийном номере, расположенном на наклейке со служебной информацией изделия. 4-я, 5-я и 6-я цифры обозначают год и неделю производства. 4-я цифра обозначает год, например, «3» обозначает, что изделие произведено в «2013» году. 5-я и 6-я цифры обозначают номер недели в году производства, например, «12» обозначает «12-ю» неделю.

Өндіруші және өндіру мерзімі

HP Inc.

Мекенжайы: 1501 Page Mill Road, Palo Alto, California 94304, U.S.

Өнімнің жасалу мерзімін табу үшін өнімнің қызмет көрсету жапсырмасындағы 10 таңбадан тұратын сериялық нөмірін қараңыз. 4-ші, 5-ші және 6-шы сандар өнімнің жасалған жылы мен аптасын көрсетеді. 4-ші сан жылын көрсетеді, мысалы «3» саны «2013» дегенді білдіреді. 5-ші және 6-шы сандары берілген жылдың қай аптасында жасалғанын көрсетеді, мысалы, «12» саны «12-ші» апта дегенді білдіреді.

Местные представители

Россия: 000 "Эйч Пи Инк",

Российская Федерация, 125171, г. Москва, Ленинградское шоссе, 16А, стр.3,

Телефон/факс: +7 495 797 35 00 / +7 499 92132 50

Казахстан: Филиал компании "ЭйчПи Глобал Трэйдинг Би.Ви.", Республика Казахстан, 050040, г. Алматы, Бостандыкский район, проспект Аль-Фараби, 77/7,

Телефон/факс: + 7 7 27 355 35 52

Жергілікті өкілдіктері

Ресей: 000 "Эйч Пи Инк",

Ресей Федерациясы, 125171, Мәскеу, Ленинград шоссесі, 16А блок 3,

Телефон/факс: +7 495 797 35 00 / +7 499 92132 50

Қазақстан: "ЭйчПи Глобал Трэйдинг Би.Ви." компаниясының Қазақстандағы филиалы, Қазақстан Республикасы, 050040, Алматы қ., Бостандық ауданы, Әл-Фараби даңғылы, 77/7,

Телефон/факс: +7 727 355 35 52

Telecom (fax) statements

The topic describes the fax statements.

Fax Cord Statement

Product may or may not have fax/telephone cord enclosed. If not provided, use only No. 26 AWG or larger telecommunication line cord to reduce the risk of fire.

Belarus statement

В соответствии с Постановлением Совета Министров Республики Беларусь от 24 мая 2017 года № 383 (об описании и порядке применения знака соответствия к техническому регламенту Республики Беларусь)

продукция, требующая подтверждения соответствия техническому регламенту Республики Беларусь, размещенная на рынке Республики Беларусь, должна быть маркирована знаком соответствия TP BY.



Brazil ANATEL statement

Este equipamento não tem direito à proteção contra interferência prejudicial e não pode causar interferência em sistemas devidamente autorizados.

Para maiores informações consulte o site da ANATEL – www.anatel.gov.br

Canada

Industry Canada CS-03 requirements:

NOTICE: The Industry Canada label identifies certified equipment. This certification means the equipment meets certain telecommunications network protective, operational, and safety requirements as prescribed in the appropriate Terminal Equipment Technical Requirement document(s). The Department does not guarantee the equipment will operate to the user's satisfaction. Before installing this equipment, users should ensure that it is permissible for the equipment to be connected to the facilities of the local telecommunications company. The equipment must also be installed using an acceptable method of connection. The customer should be aware that compliance with the above conditions may not prevent degradation of service in some situations. Repairs to certified equipment should be coordinated by a representative designated by the supplier. Any repairs or alterations made by the user to this equipment, or equipment malfunctions, may give the telecommunications company cause to request the user to disconnect the equipment. Users should ensure for their own protection that the electrical ground connections of the power utility, telephone lines, and internal metallic water pipe system, if present, are connected together. This precaution can be particularly important in rural areas.

⚠ CAUTION: Users should not attempt to make such connections themselves, but should contact the appropriate electric inspection authority, or electrician, as appropriate. The Ringer Equivalence Number (REN) of this device is shown on the regulatory chassis label.

This product meets the applicable Innovation, Science and Economic Development Canada technical specifications.

NOTICE: The Ringer Equivalence Number (REN) indicates the maximum number of devices allowed to be connected to a telephone interface. The termination of an interface may consist of any combination of devices subject only to the requirement that the sum of the RENs of all the devices not exceed five (5).

The standard connecting arrangement code (telephone jack type) for equipment with direct connections to the telephone network is CA11A.

Exigences CS-03 d'Industrie Canada:

NOTICE: l'étiquette Industrie Canada permet d'identifier les équipements certifiés. Cette certification signifie que l'équipement est conforme à certaines exigences de protection, exploitation et sécurité du réseau de télécommunication, tel que stipulé dans les documents appropriés relatifs aux exigences techniques des

équipements de type terminal. Le Département ne garantit pas que l'exploitation de l'équipement donnera pleine satisfaction à l'utilisateur. Avant d'installer cet équipement, les utilisateurs doivent s'assurer qu'il est possible de connecter l'équipement aux installations de la société de télécommunication locale. L'équipement doit également être installé en utilisant une méthode de connexion acceptable. Le client doit être conscient du fait que la conformité du matériel aux conditions citées ci-dessus n'empêche nullement des dégradations dans certaines situations. Toute réparation de l'équipement certifié doit être coordonnée par un représentant nommé par le fournisseur. Toute réparation ou altération réalisée par l'utilisateur lui-même et tout dysfonctionnement de l'équipement donne à la compagnie de téléphone le droit d'exiger la mise hors service de l'équipement. Pour des raisons de sécurité, l'utilisateur doit s'assurer que les branchements à la terre de l'installation électrique, des lignes téléphoniques et du système de conduites d'eau métalliques internes, s'il y a lieu, sont bien reliés entre eux. Cette précaution peut s'avérer particulièrement importante dans les zones rurales.

⚠ CAUTION: L'utilisateur ne doit pas tenter d'effectuer lui-même ces raccordements, mais doit contacter l'organisme de contrôle électrique approprié, ou un électricien, selon le cas. L'indice d'équivalence de la sonnerie (REN) de cet appareil est affiché sur l'étiquette réglementaire apposée sur le châssis.

Ce produit respecte les spécifications techniques applicables définies par Innovation, Science and Economic Development Canada.

NOTICE: L'indice d'équivalence de la sonnerie (REN) correspond au nombre maximum d'appareils autorisés à se connecter à une interface de téléphonie. La terminaison d'une interface peut consister en toute combinaison d'appareils soumise uniquement à l'exigence que le total des indices REN de tous les appareils ne dépasse pas cinq (5).

Le code de l'ensemble connecté standard (type de prise téléphonique) pour l'équipement associé à des connexions directes vers le réseau téléphonique est CA11A.

Europe Statement for Telecom Operation

The printer meets applicable EU Directive & UK Statutory Instruments and carries the CE & UKCA mark accordingly. For details see EU & UK Declaration of Conformity issued by the manufacturer in another section of this manual.

For printers with the feature to be connected to the analog Public Switched Telecommunication Networks (PSTN):

Due to differences between individual European national PSTNs the product may not guarantee unconditional assurance of successful operation on every PSTN termination point. Network compatibility depends on the correct setting being selected by the customer in preparation of its connection to the PSTN. Please follow the instructions provided in the user manual. If you experience network compatibility issues, please contact your equipment supplier or HP Inc. help desk in the country of operation. Connecting to a PSTN termination point may be the subject of additional requirements set out by the local PSTN operator.

New Zealand

The grant of a Telepermit for any item of terminal equipment indicates only that Telecom has accepted that the item complies with minimum conditions for connection to its network. It indicates no endorsement of the product by Telecom, nor does it provide any sort of warranty. Above all, it provides no assurance that any item will work correctly in all respects with another item of Telepermitted equipment of a different make or model, nor does it imply that any product is compatible with all of Telecom's network services.

This equipment may not provide for the effective hand-over of a call to another device connected to the same line.

This equipment shall not be set up to make automatic calls to the Telecom "111" Emergency Service.

This product has not been tested to ensure compatibility with the FaxAbility distinctive ring service for New Zealand.

Additional FCC Statement for Telecom Products (US)

This equipment complies with Part 68 of the FCC rules and the requirements adopted by the ACTA. On the back of this equipment is a label that contains, among other information, a product identifier in the format US:AAAEQ##TXXXX. If requested, this number must be provided to the telephone company.

The REN is used to determine the quantity of devices, which may be connected to the telephone line. Excessive RENs on the telephone line may result in the devices not ringing in response to an incoming call. In most, but not all, areas, the sum of the RENs should not exceed five (5.0). To be certain of the number of devices that may be connected to the line, as determined by the total RENs, contact the telephone company to determine the maximum REN for the calling area.

This equipment uses the following USOC jacks: RJ11C.

FCC-compliant telephone cord, jack and modular plug should be used with this equipment. This equipment is designed to be connected to the telephone network or premises wiring using a compatible modular jack, which is Part 68 compliant. This equipment cannot be used on telephone company-provided coin service. Connection to Party Line Service is subject to state tariffs.

If this equipment causes harm to the telephone network, the telephone company will notify you in advance that temporary discontinuance of service may be required. If advance notice is not practical, the telephone company will notify the customer as soon as possible. Also, you will be advised of your right to file a complaint with the FCC if you believe it is necessary.

The telephone company may make changes in its facilities, equipment, operations, or procedures that could affect the operation of the equipment. If this happens, the telephone company will provide advance notice in order for you to make the necessary modifications in order to maintain uninterrupted service.

If trouble is experienced with this equipment, please see the numbers in this manual for repair and (or) warranty information. If the trouble is causing harm to the telephone network, the telephone company may request you remove the equipment from the network until the problem is resolved.

The customer can do the following repairs: Replace any original equipment that came with the device. This includes the print cartridge, the supports for trays and bins, the power cord, and the telephone cord (if provided). It is recommended that the customer install an AC surge arrestor in the AC outlet to which this device is connected. This is to avoid damage to the equipment caused by local lightning strikes and other electrical surges.

Telephone Consumer Protection Act

The Telephone Consumer Protection Act of 1991 makes it unlawful for any person to use a computer or other electronic device, including fax machines, to send any message unless such message clearly contains, in a margin at the top or bottom of each transmitted page or on the first page of the transmission, the date and time it is sent and an identification of the business, other entity, or individual sending the message and the telephone number of the sending machine or such business, other entity, or individual. (The telephone number provided cannot be a 900 number or any other number for which charges exceed local or long-distance transmission charges.)

Wireless statements

The statements in this section apply to wireless-capable printers only.

FCC compliance statement—United States

Exposure to radio frequency radiation

- ⚠ CAUTION:** The radiated output power of this device is far below the FCC radio frequency exposure limits. Nevertheless, the device shall be used in such a manner that the potential for human contact during normal operation is minimized.

In order to avoid the possibility of exceeding the FCC radio frequency exposure limits, human proximity to the antenna shall not be less than 20 cm (8 in) during normal operation.

This device complies with Part 15 of FCC Rules. Operation is subject to the following two conditions: (1) this device may not cause interference, and (2) this device must accept any interference, including interference that may cause undesired operation of the device.

- ⚠ CAUTION:** Based on Section 15.21 of the FCC rules, changes of modifications to the operation of this product without the express approval by HP may invalidate its authorized use.
-

Australia statement

This device incorporates a radio-transmitting (wireless) device. For protection against radio transmission exposure, it is recommended that this device be operated no less than 20 cm from the head, neck, or body.

Belarus statement

В соответствии с Постановлением Совета Министров Республики Беларусь от 24 мая 2017 года № 383 (об описании и порядке применения знака соответствия к техническому регламенту Республики Беларусь) продукция, требующая подтверждения соответствия техническому регламенту Республики Беларусь, размещенная на рынке Республики Беларусь, должна быть маркирована знаком соответствия TP BY.



Brazil ANATEL statement

Este equipamento não tem direito à proteção contra interferência prejudicial e não pode causar interferência em sistemas devidamente autorizados.

Para maiores informações consulte o site da ANATEL – www.anatel.gov.br

Canadian statements

For Indoor Use. This digital apparatus does not exceed the Class B limits for radio noise emissions from digital apparatus as set out in the radio interference regulations of the Canadian Department of Communications. The internal wireless radio complies with RSS 210 of Industry Canada.

Pour l'usage d'intérieur. Le présent appareil numérique n'émet pas de bruits radioélectriques dépassant les limites applicables aux appareils numériques de Classe B prescrites dans le règlement sur le brouillage radioélectrique édicté par le Ministère des Communications du Canada. Le composant RF interne est conforme à la norme CNR-210 d'Industrie Canada.

China CMIIT Wireless statements

中国无线电发射设备通告

型号核准代码显示在产品本体的铭牌上。

Korean statement

무선 전용제품:

해당 무선설비는 전파혼신 가능성이 있으므로 인명안전과 관련된 서비스는 할 수 없음. (무선모듈제품이 설치되어있는경우)

Taiwan statement (Traditional Chinese)

取得審驗證明之低功率射頻器材，非經核准，公司、商號或使用者均不得擅自變更頻率、加大功率或變更原設計之特性及功能。低功率射頻器材之使用不得影響飛航安全及干擾合法通信；經發現有干擾現象時，應立即停用，並改善至無干擾時方得繼續使用。前述合法通信，指依電信管理法規定作業之無線電通信。低功率射頻器材須忍受合法通信或工業、科學及醫療用電波輻射性電機設備之干擾。

應避免影響附近雷達系統之操作。

高增益指向性天線只得應用於固定式點對點系統。

Products with 5 GHz Operation Industry of Canada

⚠ CAUTION: When using IEEE 802.11a wireless LAN, this product is restricted to indoor use, due to its operation in the 5.15- to 5.25-GHz frequency range. Industry Canada requires this product to be used indoors for the frequency range of 5.15 GHz to 5.25 GHz to reduce the potential for harmful interference to co-channel mobile satellite systems. High-power radar is allocated as the primary user of the 5.25- to 5.35-GHz and 5.65- to 5.85-GHz bands. These radar stations can cause interference with and/or damage to this device.

Lors de l'utilisation d'un réseau local sans fil IEEE 802.11a, ce produit est réservé à une utilisation en intérieur en raison de sa plage de fréquences, comprise entre 5,15 et 5,25 GHz. Industrie Canada recommande l'utilisation en intérieur de ce produit pour la plage de fréquences comprise entre 5,15 et 5,25 GHz afin de réduire les interférences nuisibles potentielles avec les systèmes de satellite portables utilisant le même canal. Le radar à haute puissance est défini comme étant le principal utilisateur des bandes 5,25 à 5,35 GHz et 5,65 à 5,85 GHz. Ces stations radar peuvent provoquer des interférences sur ce périphérique et/ou l'endommager.

Taiwan NCC Statement:(Only for 5GHz)

應避免影響附近雷達系統之操作。

Exposure to Radio Frequency Radiation (Canada)

- ⚠ WARNING!** Exposure to Radio Frequency Radiation. The radiated output power of this device is below the Industry Canada radio frequency exposure limits. Nevertheless, the device should be used in such a manner that the potential for human contact is minimized during normal operation.
- ⚠ WARNING!** Exposition aux émissions de fréquences radio. La puissance de sortie émise par ce périphérique est inférieure aux limites fixées par Industrie Canada en matière d'exposition aux fréquences radio. Néanmoins, les précautions d'utilisation du périphérique doivent être respectées afin de limiter tout risque de contact avec une personne.

To avoid the possibility of exceeding the Industry Canada radio frequency exposure limits, human proximity to the antennas should not be less than 20 cm (8 inches).

Pour éviter tout dépassement des limites fixées par Industrie Canada en matière d'exposition aux fréquences radio, la distance entre les utilisateurs et les antennes ne doit pas être inférieure à 20 cm (8 pouces).

European regulatory notice

The telecommunications functionality of this product may be used in the following European countries/regions:

Austria, Belgium, Bulgaria, Cyprus, Czech Republic, Denmark, Estonia, Finland, France, Germany, Greece, Hungary, Iceland, Ireland, Italy, Latvia, Liechtenstein, Lithuania, Luxembourg, Malta, Netherlands, Norway, Poland, Portugal, Romania, Slovak Republic, Slovenia, Spain, Sweden, Switzerland, and United Kingdom.

Notice for use in Russia

Существуют определенные ограничения по использованию беспроводных сетей (стандарта 802.11 b/g) с рабочей частотой 2,4 ГГц: Данное оборудование может использоваться внутри помещений с использованием диапазона частот 2400-2483,5 МГц (каналы 1-13). При использовании внутри помещений максимальная эффективная изотропно-излучаемая мощность (ЭИИМ) должна составлять не более 100мВт.

Mexico statement

Aviso para los usuarios de México

"La operación de este equipo está sujeta a las siguientes dos condiciones: (1) es posible que este equipo o dispositivo no cause interferencia perjudicial y (2) este equipo o dispositivo debe aceptar cualquier interferencia, incluyendo la que pueda causar su operación no deseada."

Para saber el modelo de la tarjeta inalámbrica utilizada, revise la etiqueta regulatoria de la impresora.

Thailand statement

เครื่องวิทยุคมนาคมนี้มีระดับการแผ่คลื่นแม่เหล็กไฟฟ้าสอดคล้องตามมาตรฐานความปลอดภัยต่อสุขภาพของมนุษย์จากการใช้เครื่องวิทยุคมนาคมที่คณะกรรมการกิจการโทรคมนาคมแห่งชาติประกาศกำหนด

This radio communication equipment has the electromagnetic field strength in compliance with the Safety Standard for the Use of Radio Communication Equipment on Human Health announced by the National Telecommunications Commission.



 **NOTE:** Telecom wireless marking for ICTQC Type approved products.

Dynamic Security Enabled Printers

This printer is intended to work only with cartridges that have a new or reused HP chip. A reused HP chip enables the use of reused, remanufactured, and refilled cartridges.

The printer uses dynamic security measures to block cartridges using a non-HP chip. Periodic firmware updates delivered over the internet will maintain the effectiveness of the dynamic security measures and block cartridges that previously worked.

Updates can improve, enhance, or extend the printer's functionality and features, protect against security threats, and serve other purposes, but these updates can also block cartridges using a non-HP chip from working in the printer, including cartridges that work today. Unless you are enrolled in certain HP programs such as Instant Ink or use other services that require automatic online firmware updates, most HP printers can be configured to receive updates either automatically or with a notification that allows you to choose whether to update or not. For more information on dynamic security and how to configure online firmware updates, please go to www.hp.com/learn/ds.